

# REPLACEMENT PARTS FOR CHORE BOY

MILKING MACHINES

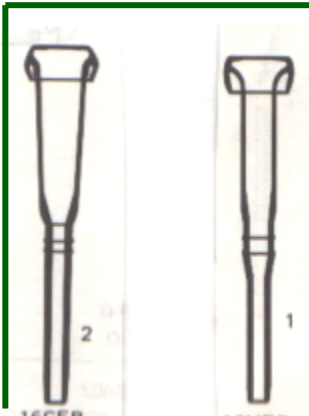

## INFLATIONS

16CEB Small Bore for Regular Shell **10168**

16HEB Small Bore **10124**



**# 10304**



## SHORT AIR HOSE

9/32" x 6 1/2" for Floor Model  
INV # **10657**

1/4" ID x 6 1/2" for Suspended Model  
INV # **10628**

**PAIL LID GASKET** (suspended model)  
**101SEB**



**# 10460**

**CLAW PLUG**  
**44CEB**

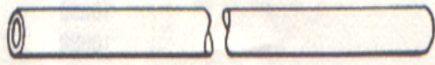

**TRANSPARENT MILK HOSE**  
(5/8" x 25") INV # **10956**



## RUBBER AIR HOSE

Stall Cock to Pulsator  
(7/16" x 90")  
INV # **10813**

**WASHER PLUG**  
INV# **10452**  
PART # **41CEB**

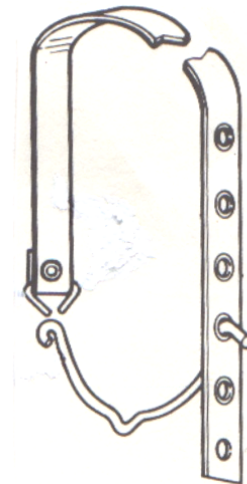

**SURCINGLE**  
Rod Only **10500**  
Triangle Only **10492**  
Strap w/Triangle  
**10484**

**PLEASE CALL US WITH ANY  
QUESTIONS YOU MAY HAVE.  
OUR STAFF HAS DECADES OF  
EXPERIENCE THAT WILL HELP  
YOU FIND JUST WHAT YOU'RE  
LOOKING FOR QUICKLY AND  
EASILY!**

# REPLACEMENT PARTS FOR CONDE

MILKING MACHINES

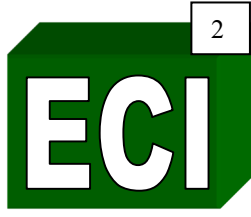

**Small Bore Inflation with Cushion Top**  
INV #10124  
Part #16HEB

**Short Air Hose for "400" Short Tube Model**  
Black – 7/32" x 8" reinforced ends #10618



**Short Air Hose for Long Shell # 10609**  
Black – 7/32" x 7" Part # A7NR



**CLAW CAP FOR STANDARD MODEL**

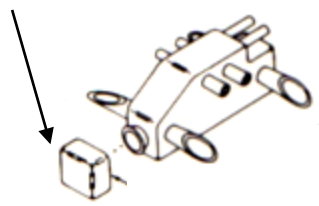

#10448



**Claw Plug for "400" Model #10460**  
(44CEB)

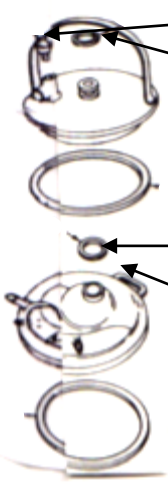

**Rubber Milk Inlet Plug #10452B** (41CEB)

**Flat Pulsator Gasket for "400" #10434**  
1 1/4" x 2" x 1/4" rubber (43CEB)

**Pulsator Gasket O-ring for "400" #10436**

**Flat Pulsator Gasket for Standard #10300**  
6 3/8" ID x 7 1/4" OD x 3/8" thick – black (110CEB)

**Transparent Milk Hose**  
Standard Model SU (5/8 x 25") #10956  
(Part # Y25TE)  
OR  
"400" Model SU (9/16" x 26 1/2") #10908  
(Part # W26 1/2TE)

**Duplex Air Hose**  
Standard Model SU (1/4" x 1/4" x 27")  
Our # 10969 (Part #DD27NR)

**Surcingle Parts**  
Rod Only #10500  
Triangle Only #10492  
Strap w/Triangle # 10484

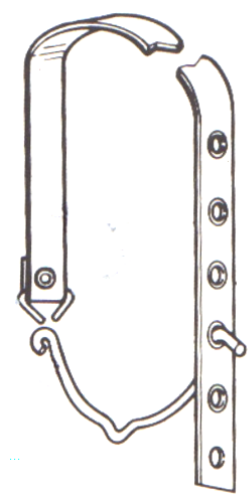

# REPLACEMENT PARTS FOR DARI-KOOL BOU-MATIC

INFLATION – NOT MILK TUBE

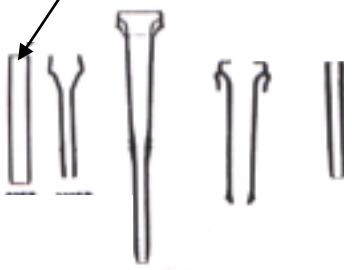

GUIDE TO BOU-MATIC INFLATIONS (From Left to Right)		
Liner – Black – Small Bore	10180	03EB
SANI CAP	10176	300EB
INFLATION – Small Bore – Cushion Top	10182	16BMEB
MULTI-PIECE INFLATION	10184	16R2EB
MILK TUBE – 3/8" x 5 1/4"	10185	16R2MT

## PAIL LID GASKET



INV# 10304  
PART # 101SEB



**DUPLEX AIR HOSE**  
1/4" x 1/4" x 108"  
  
INV# 11009

**IF YOU DON'T SEE  
WHAT YOU'RE AFTER,  
WE CAN PROBABLY  
FIND IT FOR YOU**



**SHORT AIR HOSE 1/4" x 8"**  
INV# 10637

**RUBBER MILK HOSE** (NOT SHOWN)  
BLACK – 9/16" x 108"  
  
INV # 10925  
  
**OR**  
  
**PLASTIC TRANSFLOW AIR HOSE**  
BLACK – 3/8" x 90" (NOT SHOWN)

**We also carry Transflow tubing in all sizes**  
  
**If you need some 5/8" cut to length, we can do that!**  
  
**Toll Free (877) 829-3505**

# REPLACEMENT PARTS FOR DE LAVAL

MILKING MACHINES

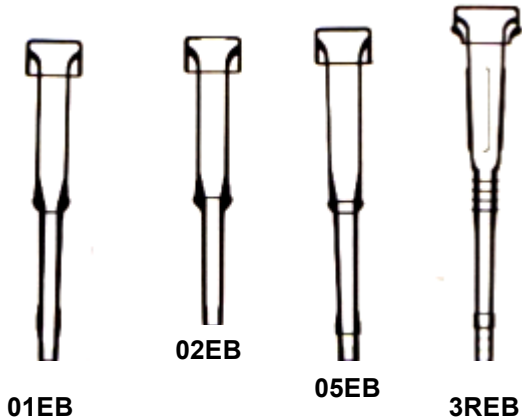

## INFLATIONS

01EB	For 06 Shell – Small Bore	#10052
02EB	For 06 Shell – Small Bore, Short Tube	#10056
05EB	For 06 Shell – Medium Bore	#10064
3REB	For 0820 Shell – Medium Bore	#10076



**SANI CAP for 0277 Shell**  
Part # 300EB

# 10176



**NIPPLE CLOSURE**  
# 10425

## SHORT AIR HOSES

For 06 Shell (9/32" x 6 1/2") #10657  
Part # G6 1/2NR

For 06, 0820 Shell (9/32" x 9") #10665  
Part # G9NR

For 0277 Shell (9/32" x 7 1/4") #10661  
Part # G7 1/4NR



## AIR HOSES

### Single Air Hose for Single Unit

9/32" x 28" #10667

For Pipeline 9/32" x 108" #10696

### Duplex Air Hose For Single Unit

9/32" x 9/32" x 28" #11017

For Pipeline (same dimensions as above)  
#11037

## SURCINGLE PARTS

Strap w/Triangle	10484
Triangle Only	10492
Rod Only	10500

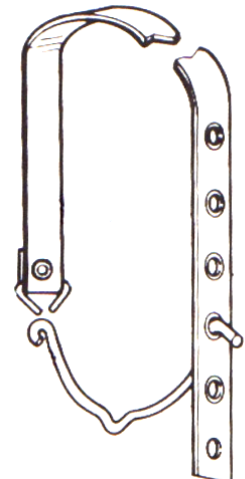

**EASTERN CROWN, INC. DISTRIBUTOR OF DAIRY SUPPLIES SINCE 1947**



# Replacement Parts for Surge

MILKING MACHINES

**DON'T NIX  
EM' WHEN  
YOU CAN  
FIX EM'!!**

**CALL  
(877) 829-3505**

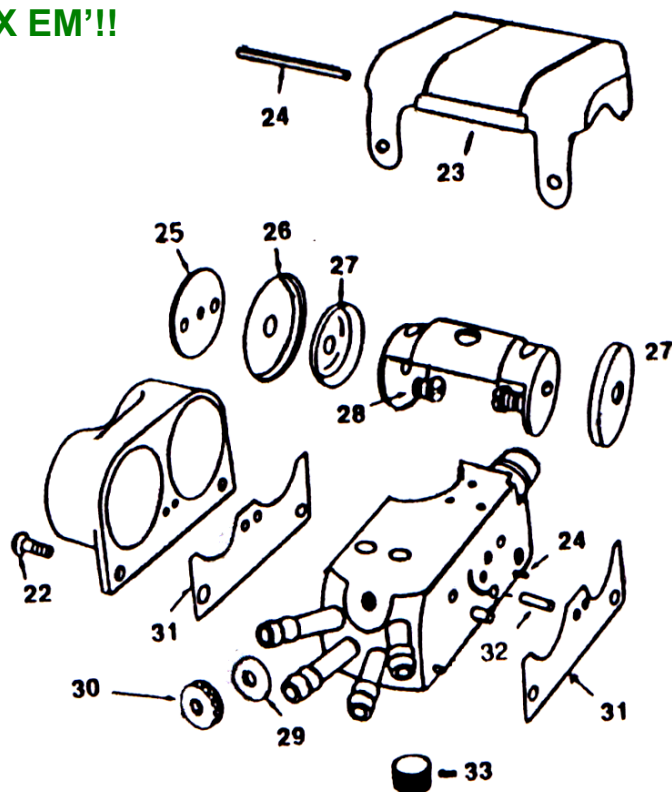

## PULSATOR REPAIR KIT



21	<b>PULSATOR REPAIR KIT CONSISTS OF 4 PISTON LEATHERS, 4 PISTON LEATHER EXPANDERS, 2 CYLINDER GASKETS, 1 REGULATING SCREW LEATHER LOCK WASHER, 1 O-RING.</b>	10503
22	CYLINDER SCREW	10564
23	COVER SEAL	10584
24	HINGEPIN AND GASKET	10552
25	PISTON END PLATE	10560
26	PISTON LEATHER	10508
27	PISTON LEATHER EXPANDER	10544
28	PISTON PLATE SCREW	10556
29	REGULATING SCREW LOCK WASHER	10520
30	REGULATING SCREW LOCK NUT	10516
31	CYLINDER GASKET	10504
32	BLOCK PIN	10528
33	CLEAN OUT PLUG	10580

# Replacement Parts for SURGE

MILKING MACHINES

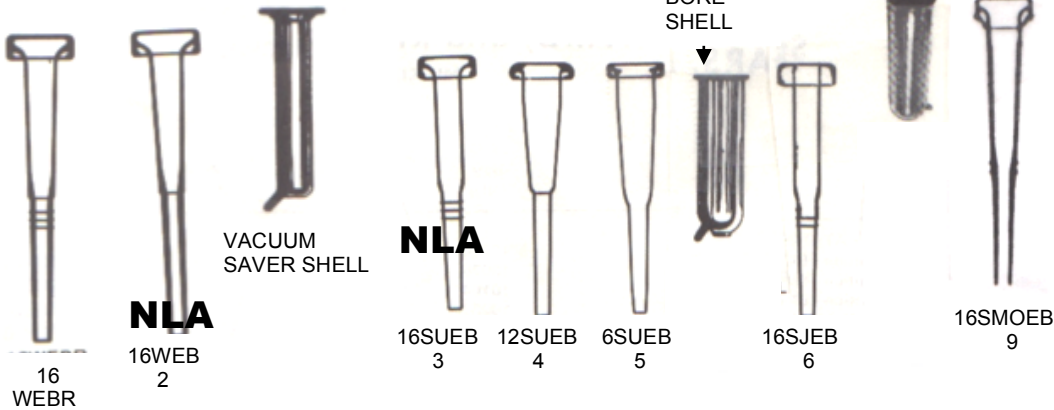

**INFLATIONS**

- |   |  |       |
|---|--|-------|
| 1 | Inflation for Vacuum Saver shell – Black – Ultra Small Bore        | 10172 |
| 2 | Inflation for Vacuum Saver Shell – Black – Ultra Small Bore        | 10048 |
| 3 | Inflation for Large Bore Shell – Black – Small Bore – Cushion Top  | 10040 |
| 4 | Inflation for Large Bore Shell – “ – Tapered Body – Cushion Top    | 10036 |
| 5 | Inflation for Large Bore Shell - “ – Tapered Body – Solid Top      | 10020 |
| 6 | Inflation for Jet-Flo Shell – “ – Black – Small Bore – Cushion Top | 10050 |
| 7 | Inflation for Jet-Flo Shell and Mini-Orbit Unit – Large            | 10038 |

**SHORT AIR HOSES**

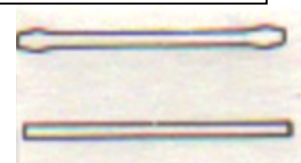

- |   |       |
|---|-------|
| SHORT AIR HOSE – 7/32” ID x 8” Molded Reinforced Ends – Black | 10618 |
| SHORT AIR HOSE – 7/32” ID x 8” Striaight Hose – Black         | 10617 |
| SHORT AIR HOSE – 7/32” x 9” Straight Hose – Black             | 10621 |



**NIPPLE CLOSURE**  
Overall Length 2”

# 10425

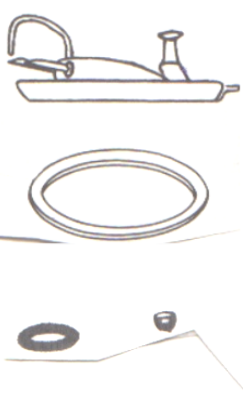

**PAIL LID GASKETS AND PARTS**

- |  |       |
|--|-------|
| Pail Lid Gasket – Molded with Flange – Black       | 10304 |
| Pulsator Base “O” Ring for all Surge Milkers       | 10532 |
| Check Valve Complete – For all Surge Bucket Milker | 10548 |
| Check Valve – Seat Only – Rubber – Black           | 10512 |



**LONG AIR HOSES**

Single Air Hose, 7/16” ID x 90” long – Rubber - Black

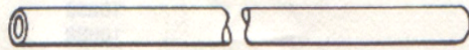

**MILK HOSES**

Milk Hose, 9/16” ID x 108” Long – Rubber - Black

**SURCINGLE PARTS**

- |                                |       |
|--------------------------------|-------|
| Surcingle Strap w/Triangle 96” | 10484 |
| Surcingle Triangle Only        | 10492 |
| Surcingle Rod Only             | 10500 |

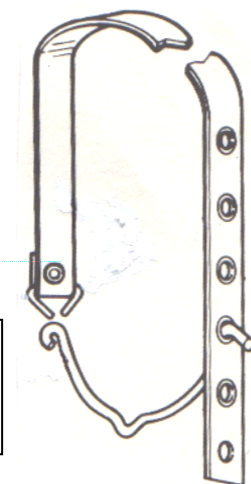

# THE RIGHT BRUSH FOR YOUR APPLICATION

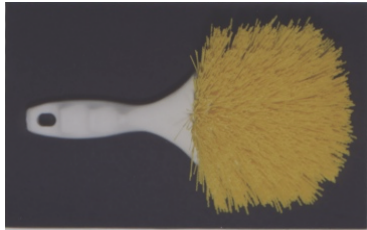

## PLASTIC BLOCK – COLOR CODED

Crimped synthetic bristle to visibly reduce possibility of cross contamination.

- # 20044 8", yellow nylon bristles
- # 20048 8", white crimped nylon
- # 20052 8", Made of Prostran, resists acid and boiling water
- # 20732 8", red synthetic bristle



## PLASTIC BLOCK UTILITY – 8 INCH

They float! Lightweight and will not absorb water or odor.

- # 20008 ECI-520 Oval face w/ white crimped nylon
- # 20012 ECI-520F Flat face w/ white crimped nylon



## PAIL BRUSH

White crimped nylon bristle, plastic block

- # 20004 ECI-455



## 20 INCH PLASTIC BLOCK UTILITY BRUSH

The ultimate back brush! Length reaches hard-to-get-at areas in a farm or plant.

- # 20056 Yellow nylon bristles
- # 20060 White crimped nylon
- # 20064 Prostran: acid and boiling water resistant
- # 20066 Red Synthetic bristles



## WATER-FLOW TRUCK AND WALL BRUSH

Acriliflo Truckwash. 10" plastic block with 1 threaded and 1 tapered handle hole. Gray flagged acriliflo bristles, 2 1/2" trim. Protective vinyl bumper. Use with 20900-1 Lumathread Handle.

**AN AWESOME WORKER FOR YOU!**

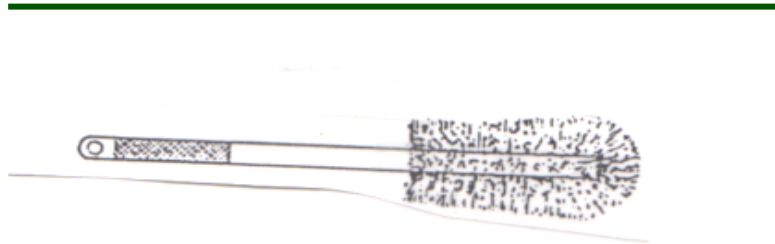

## BOTTLE, GLASS AND JAR BRUSHES – PINT SIZE

Quickly cleans various size bottles, pitchers, blenders, glassware and sample jars. White sanitary plastic handles. 2 1/2" dia x 12" long.

- # 20712 Yellow synthetic
- # 20714 White synthetic
- # 20716 Red synthetic bristles

## BOTTLE, GLASS AND JAR BRUSHES – QUART SIZE

Same as above except 3 1/4" x 15"

- # 20724 Red synthetic
- # 20725 Yellow synthetic
- # 20726 White synthetic

## HAND STYLE QUART BOTTLE BRUSH # 20610

Plastic handles with knurled grips for greater control. 100% sanitary soak-proof design. Springy white nylon bristles wound in stainless steel wire. Overall length 16".

## HAND STYLE HALF GALLON BRUSH # 20606

Same as above except brush part is 7 1/4" with 4" diameter.

# BRUSHES



## REGULAR TANK AND KETTLE BRUSH

No metal parts. Will not chip, crack or cause slivers. Made with Soak-Proof materials. Sizes 7 1/2" or 9"

Regular		Large
# 20072	White synthetic	20070
# 20463	Red synthetic	20480
# 20465	Yellow synthetic	20482

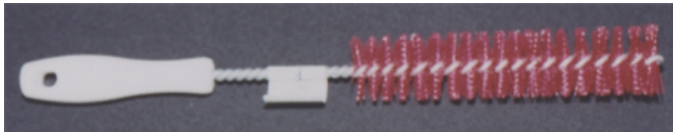

## COLOR-CODED VALVE BRUSH

5" foam plastic handle connected to a 9" stiff synthetic bristle brush. Overall length 20".

# 20455	1 1/2" red bristle
# 20455-3	3" diameter red bristle
# 20457	1 1/2" white bristle



# 20028

## KLEEN KWIK SR. - 7 1/2" BRUSH

With sponge action fill to give you the best of both worlds.

Works with 20912, 20922, 20926  
Handles

## VACUUM POCKET BRUSH

Specially designed for cleaning vacuum pockets Of inflations and around check valves on lids.

Brushes are a mixture of fine and coarse nylon.

Superior water-carrying ability!

#20152

# Lab Brushes

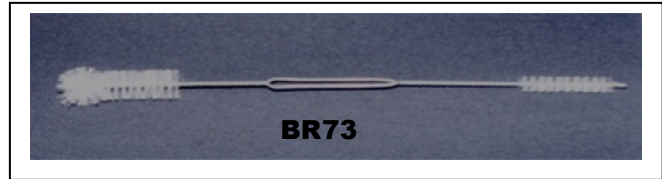

**BR73**  
Double end with loop grip. 3/4" dia. Radial end, 1/2" tube cleaning end.

- |       |   |
|-------|---|
| 20332 | (BR31) Double end with radial tip for cleaning Pulsator, lid and claw pockets. All nylon. |
| 20304 | (BR73) Specially designed to clean DeLaval claw. 15" long overall.                        |
| 20341 | (425) Double-ended for superior cleaning  |



**CLAW BRUSH BR31 #20332**

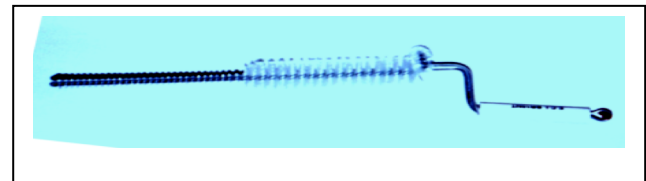

## INFLATION BRUSHES

For **Small Bore Inflations**

BR5NT: White crinkled Tynex nylon 20100

For **Medium Bore Inflations:**

BR6NT: White crinkled Tynex nylon 20096

For **Large Bore Inflations:**

BR10NT: Tynex nylon -92

## TUBE BRUSHES

INV#: Single end made of nylon

20320 9" x 3" x 1/4" (L x brush L x diam)

20324 9" x 3" x 1/2"

20328 9" x 3" x 5/8"

Made of a mix of various gauge nylons.

20148 BR26 15" x 3" x 3/8"

20136 BR34 28" x 3" x 1/2"

20140 BR38 28" x 3" x 5/8"

20144 BR40 28" x 3" x 11/16"

# DAIRY BRUSHES

CALL TOLL FREE  
(877) 829 3505

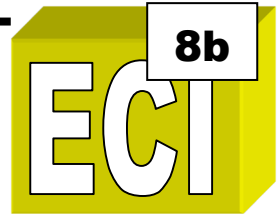

BRUSH STYLE AND SPECIFICATIONS SUBJECT TO CHANGE. FOR COMPLETE INFO, CALL TOLL FREE (877) 829-3505

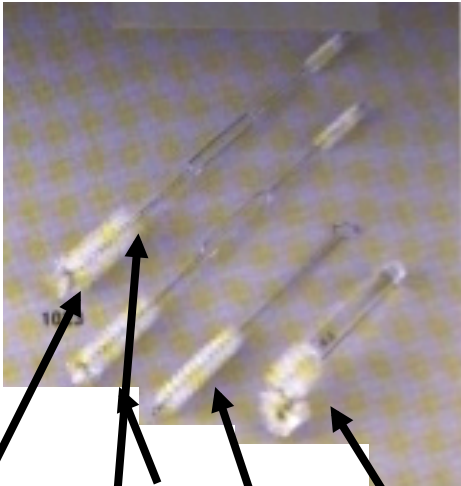

## CLAW BRUSHES

- BR73 20340 Double end with loop grip 3/4" dia. Radial End
- BR31 20332 Double end with radial tip for cleaning the pulsator, lid and claw pockets. All nylon.
- 425 20341 Double-ended for superior cleaning



EASTERN CROWN, INC. CARRIES A COMPLETE VARIETY OF BRUSHES AND BROOMS FOR THE DAIRY INDUSTRY, BUT WE DON'T LIKE TO BRAG.



## INFLATION BRUSHES

- FOR SMALL BORE INFLATIONS  
BR5NT #20100
- FOR MEDIUM BORE INFLATIONS  
BR6NT #20096
- FOR LARGE BORE INFLATIONS  
BR10NT #20092

## TUBE BRUSHES

- (9" x 3") Nylon
- # 20320 1/4" diameter
- 20324 1/2" diameter
- 20328 5/8" diameter
- (15" x 3")
- 20148 3/8" diameter
- 20136 1/2" diameter
- 20140 5/8" diameter
- 20144 11/16" diameter

## VACUUM POCKET BRUSH

# 20152

Specially designed for cleaning vacuum pockets of inflations and around check valves on lids. Brushes are a mixture of fine and coarse nylon.

Superior water-carrying ability!

CALL US IF YOU HAVE A QUESTION ABOUT WHICH BRUSH WILL WORK BEST FOR YOU. WE HAVE AN EXPERIENCED PARTS DEPARTMENT READY TO HELP.

**EASTERN CROWN, INC. DISTRIBUTOR OF DAIRY SUPPLIES SINCE 1947**



## WHAT'S YOUR HANDLE?

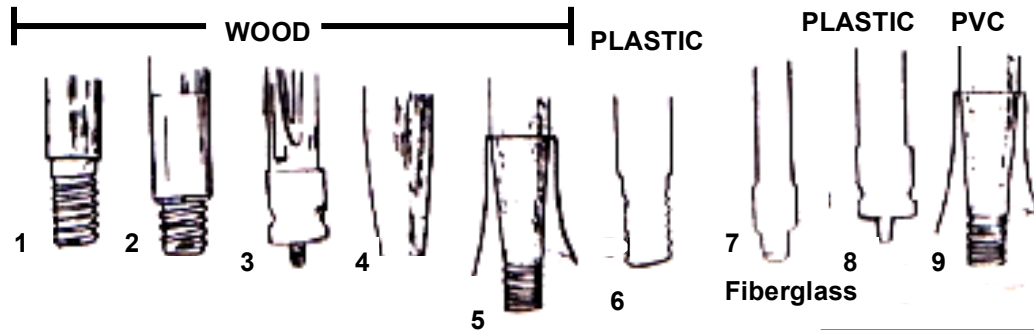

**1 Threaded Floor Brush Handles**  
 20896 3' wood w/clear lacquer  
 20896-1 3 1/2' wood "  
 20896-2 4' wood "  
 20896-3 5' wood "  
 20896-4 6' wood "

**5 LITE-N-TITE Socket design**  
 draws handle into a very tight fit.  
 21026 4' x 1" hardwood  
 21014 5' x 1" hardwood  
 21015 6' x 1" hardwood

**2 Lumathread Floor Brush Handles**  
 diecast metal threaded tip  
 20900 3'  
 20900-1 4'  
 20900-2 5'  
 20900-3 6'

**6 Plastic Handle for 20070 and 20072 only.**  
 20916 Plastic 36" x 1"  
 20914 Plastic 48" x 1"

**3 Bolt Threaded End Handles**  
 Lacquered hardwood w/nylon ferrule and bolt threaded end.  
 20912 18-42"  
 20912-1 18-54"

**7 Fiberglass Handle**  
 20800 Threaded 36"  
 20804 Threaded 48"  
 20808 Threaded 60"

**4 Tapered End Handles (2003T)**  
 Smooth sanded finish.  
 20908 4 1/2'  
 20908-1 5'  
 20908-2 6'

**8 Plastic Bolt Threaded End Handles. Non-slip grip.**  
 20922 42"  
 20926 60"

**9 LITE-N-TITE Handles PVC**  
 21028 48"  
 21029 60"

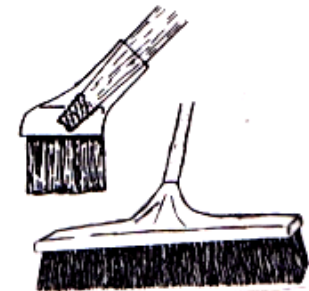

**LITE-N-TITE**

- CAN'T BEND, BREAK, OR CRACK
- UNAFFECTED BY ACIDS, OIL OR WATER
- NO FIBER FALLOUT, NO BROKEN HANDLES

# 21000 18" x 3"  
 21002 18" x 3"  
 21004 24" x 3"  
 21006 18" x 3" blue  
 21008 24" x 3" blue

# 20920

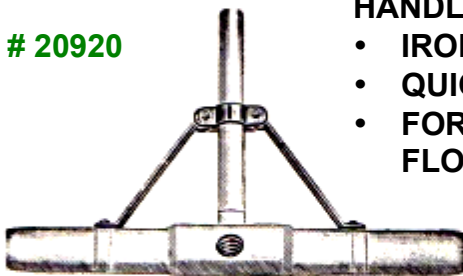

**HANDLE BRACE**

- IRON LEGS
- QUICK MOUNTING
- FOR EXTRA LONG FLOOR BRUSHES

**38x "HI-LO" FLOOR SCRUB # 20088**



UNIQUE DESIGN ALLOWS YOU TO CLEAN STRAIGHT UP OR DOWN UNDER!

**SUPPLIES SINCE 1947**

# GASKETS

CALL (877) 829-3505  
FOR SPECIAL SIZES

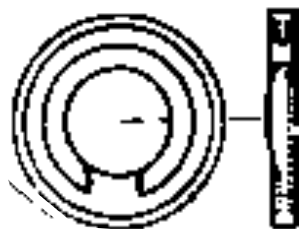

Flapper Gasket for Surge  
Pipeline # 41173



#### SURGE PIPELINE

41179 1 1/2"  
41180 2"

#### DELAVAL PIPELINE

41181 1 1/2"  
41182 2"

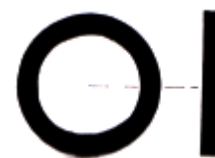

#### HAYNES CUSHION SEAL

41142 1 1/2"  
41143 2"  
41144 2 1/2"  
41145 3"

#### HAYNES SNAPTITE BEVEL SEAT GASKET

41136 1 1/2"  
41137 2"  
41138 2 1/2"  
41139 3"



#### FOR STANDARD CLAMP FITTING

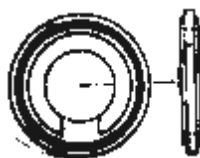

41175 1 1/2"  
41176 2"

#### FOR DELAVAL PIPELINE



# 41177

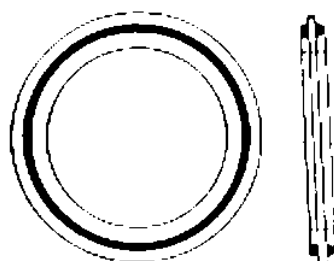

#### PIPELINE GASKETS STANDARD CLAMP TYPE FITTING

41161 1 1/2"	<u>WHITE TEFLON</u>
41162 2"	41168 1 1/2"
41163 2 1/2"	41169 2"
41164 3"	41170 2 1/2"
41165 4"	41171 3"

#### STANDARD BEVEL SEAT GASKET

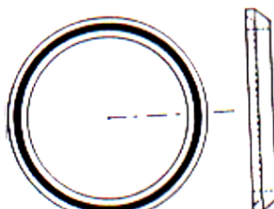

41154 1"	<u>WHITE TEFLON</u>
41155 1 1/2"	41148 1 1/2"
41156 2"	41149 2"
41157 2 1/2"	41150 2 1/2"
41158 3"	41151 3"
41159 4"	

#### RIDAK PAPER GASKETS

Eastern Crown, Inc. offers  
many sizes and widths by  
special order.

#41152 1 1/2"

41153 2"

NOT ILLUSTRATED



# GASKETS AND O-RINGS

# TESTING

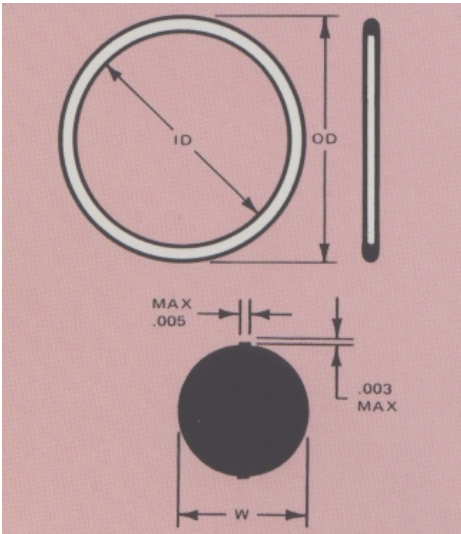

HOW TO SIZE YOUR O-RING



**TEST FOR KETONE OR  
MASTITIS WITH  
TESTS FROM**

*PORTACHECK*

*WWW.PORTACHECK.COM*

<b>42044</b>	<b>PORTASCC 24 TEST</b>
<b>42045</b>	<b>PORTASCC 100 TEST</b>
<b>42046</b>	<b>DIGITAL READER</b>
<b>42047</b>	<b>PORTACHECK BHB-KETONE 25 TEST</b>
<b>42041</b>	<b>PORTASCC GOAT 40 TEST</b>

## MANHOLE GASKETS



Double Flanged  
Molded  
# 63060



Single Flanged  
Molded  
# 63061



Universal  
Fabricated\*  
# 63062

\* Universal Gasket will fit all standard 16" x 20" doors, with the exception of Phaudler.

63076 For Round Zero Bulk Tank Cover

63078 For Oval Zero Bulk Tank Cover

63084 For Universal Bulk Tank Cover

### SIGHT GLASS GASKET

# 63070	4" x 1/4"
63071	4 3/4" x 1/4"
63072	7 5/8" x 1/4"

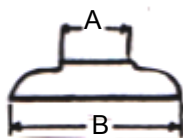

70178	3351	1"	3 7/8"
70180	FT007D	3/4"	4 1/2"

INV	PART#	SIZE A	SIZE B
63080	700314	7/8"	3 3/4"
70170	7000390	1"	4 1/4"
70172	5708390	1 1/2"	3 7/8"
70174	3952	1 5/16"	3 7/8"
70176	3118	1 1/4"	3 7/8"

ZERO  
SUNSET  
SUNSET  
MUELLER  
MUELLER



**CALL  
(877) 829-3505 FOR  
MORE INFO**

**CALL US**

# CLAMPS

**STAINLESS STEEL HEAVY DUTY CLAMP**



63340	1 1/2"
63342	2"
63343	2 1/2"
63344	3"
63345	4"

**V-INSERT CLAMP**



70060	1 1/2"
70061-1	2"
70062	2 1/2"
70062-1	3"

**HI IMPACT PLASTIC CLOSURE**



**MALE**

- 55832 1 1/2"
- 55836 2"
- 55840 2 1/2"
- 55844 3"

**FEMALE**

- 55834 1 1/2"
- 55838 2"
- 55842 2 1/2"
- 55846 3"



**STAINLESS STEEL HINGED TOGGLE CLAMP**



30475	1 1/2"
30474	2"
30475-1	2 1/2"
30475-2	3"



**STAINLESS STEEL T-BOLT CLAMPS FOR SPIRALITE HOSE**

- 41101 1 1/2"
- 41102 2"
- 41103 2 1/2"
- 41116 3"

Clamp sizes are the size of the hose.

**QUICK COUPLER SANITARY HOSE CLAMPS**



**INV#**

- 41084 1 1/4"
- 41088 1 1/2"
- 41092 1 7/8"
- 41096 2"
- 41100 2 1/4"
- 41104 2 1/2"
- 41108 2 3/4"
- 41112 3"
- 41116 3 1/2"
- 41120 4"
- 41124 T-bolt for 1 1/2" – 2" clamps
- 41126 Wing Nut for 1 1/2" to 2" clamps
- 41128 T-bolt for 2 1/2" to 4" clamps
- 41130 Wing nut for 2 1/2" to 4" clamps

# KenAG Filters



Has the Filter  
For your  
Application!

INV #	DESCRIPTION
42496	6" KENDALL FILTER (CS/36) #D107
42500	6 1/2" KENDALL FILTER (CS/36) #D110
42504	7" KENDALL FILTER (CS/24) #D112
42508	8" KENDALL FILTER (CS/24) #D115
42516	4 9/16" KEN. FILTER (CS/36) #D506
42524	12 1/2" KEN. FILTER (CS/10) #D531
42528	15" KENDALL FILTER (CS/10) #D532
42554	2 1/4" x 12" BRKPRF (CS/12) #D579
42558	2 3/4" x 23 1/2" ULTRA (CS/6) #D591
42560	3" x 23 3/8" BRKPRF (CS/6) #D572
42563	2 1/4" x 24" BRKPRF (CS/6) #D577
42564	2 1/4" x 24" ULTRAFLW (CS/6) D589
42566	2 1/4" x 6 1/2" BRKPRF (CS/12) #D541
42570	4 7/8" x 17" BRKPRF (CS/10) #D547
42572	4 7/8" x 17" SOCK
42575	2" x 24" BRKPRF (CS/6) #D576
42576	2 1/4" x 24" LO PRESS. (CS/12) D568
42579	4 7/8" x 33 1/2" SOCK (CS/9BX) #D548
42580	4 7/8" x 33 1/2" BRKPRF (CS/9) #D538
42581	4 7/8" x 36" BRKPRF (CS/9) #D539
42582	2 1/4" x 5 1/2" LO PRESS. (CS/12) #D550
42584	3 1/4" x 22" ULTRAFLW (CS/10) #D522
42600	AQUA MAST (CS/12) #D865
42612	UDDER CREAM (CS/12) # D806
42612-1	UDDER CREAM (JAR) #D806
42620	TEAT DILATORS (CS) #D841
42630	FIRST CHOICE DRY COW (CS) #D866
42634	2" x 24" ULTRA FLOW (CS/6) #D588
42640	FILTER DISPENSER (4 7/8 x 33 1/2") #D792
49000	1 1/2" SANI GUIDES (BAG) #D771
49004	2" SANI GUIDES (BAG) #D772
49008	3" SANI GUIDES (BAG) #D773
49010	SANI GUIDES PLASTIC BAGS #D775

### TIPS FOR ORDERING:

- A) CHECK KenAG # (begins with a D)
- B) To Order Individual Boxes, simply add a "-1" to the numbers you see to the left

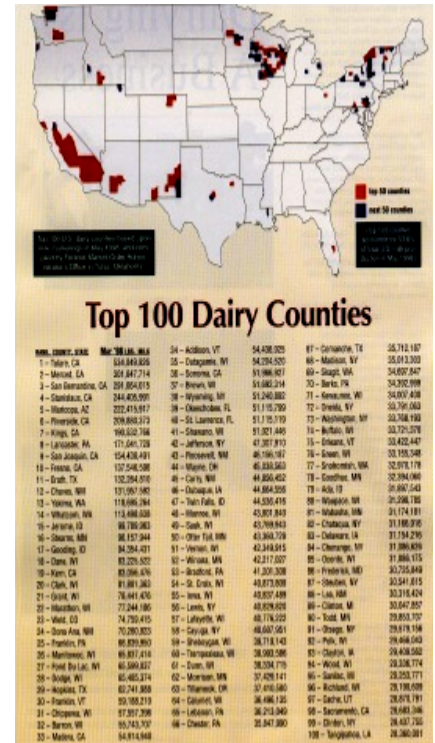

Serving the best in the industry

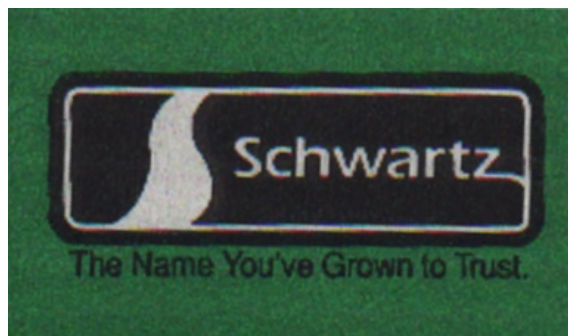

## EASTERN CROWN CARRIES THE BEST IN MILK FILTERS

### FILTER CLEAN DISCS

40450 6 ½"  
40456 12 ½"  
40458 15"

### TUFFY DISCS

40454 4 9/16"  
40455 9 ½"

### TUFFY SOCK

40459 2 ¼" x 6"  
40460 2 ¼" x 12"  
40462 2" x 24"  
40464 2 ¼" x 24"  
40466 2 ½" x 23 ½"  
40468 2 ¾" x 23 ½"  
40470 3" x 23 ½"  
40476 4 7/8" x 28"  
40479 4 7/8" x 33 ½"

### PERFECT FIT SOCK

40483 12"  
40484 24"

### FAST STUFF

40486 12" x 16"

### ROLL-FAST STUFF

40488 12" x 200'

### FLANNEL SOCK

40463 2 3/16" x 24"

### TUFFY SLEEVE

40472 3 5/16" x 22 ¼"  
40474 4 7/8" x 17"  
40478 4 7/8" x 33 ½"  
40480 4 7/8" x 36"

### MISC.

30400 PERFECT FIT – 24" FILTER  
ASSEMBLY  
30402 RETAINER TRI-CLAMP  
30404 RETAINER – SURGE – PERFECT FIT  
55850 FILTER SUPPORT  
55852 FILTER SLEEVES (BOX)

**IMPORTANT! TO ORDER IN VOLUME, SIMPLY  
ADD THE FOLLOWING THE INVENTORY  
NUMBER:**

*-1 for a box of filters*

**THANK YOU FOR YOUR ORDER AT  
(877) 829 3505**

**EASTERN CROWN DISTRIBUTORS OF**





# JABSCO PUMP PARTS

TOLL FREE  
(877) 829 3505



Model 15170-Series

## EXPLODED VIEW Model 15170-Series

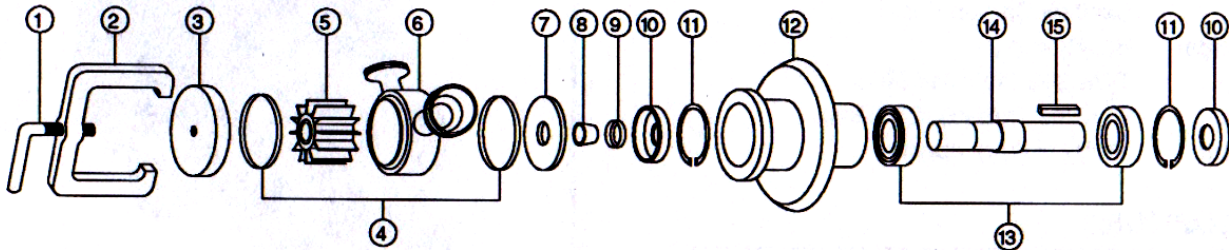

### KEY #

1	CLAMP SCREW	63000
2	CLAMP	63002
3	END COVER	63004
4	O-RING	63028
5	IMPELLER	63006
5A	GENERIC IMPELLER	63006-1
6	BODY	63032
	BODY (CIP)	63034
7	WEARPLATE	63008
8	SEAL	63010

### KEY #

9	SEAL COLLAR	63012
10	BEARING SEAL	63014
11	RETAINING RING	63016
12	BEARING HSG	63018
13	BALL BEARING (2)	63020
14	SHAFT	63022
15	KEY	63024
10/15	BRG HSG ASSEMBLY COMPLETE	

## 2 1/2" PUMP PARTS

<b>62981</b> – 21908	CLAMP SCREW	<b>62990</b> – 91701 – RETAINING RING
<b>62982</b> – 21909	CLAMP FRAME	<b>62991</b> – 22064 – BEARING HOUSING
<b>62983</b> – 22007	END COVER	<b>62992</b> – 0460 – ROLLER BEARING
<b>62984</b> – 9200-1213	O-RING	<b>62993</b> - 21978 - 000 - SHAFT
<b>62985</b> – 8500-0005	IMPELLER	<b>62994</b> – 91402 – KEY
<b>62986</b> – 22004	BODY	<b>62995</b> – 0450 – BALL BEARING REAR
<b>62987</b> – 21937	WEAR PLATE	<b>62996</b> – 917 – RETAINING RING
<b>62988</b> – 22644	SEAL KIT	
<b>62989</b> – 92701	BEARING SEAL	

**BULK HAULER**

(877) 829 3505

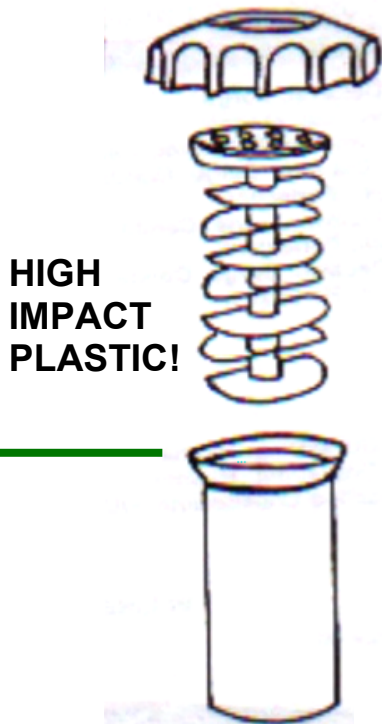
**CANNOT JAM OR COLLAPSE!****HIGH  
IMPACT  
PLASTIC!**

**THE RUNOVENT AIR VENT IS DESIGNED TO ALLOW UNRESTRICTED AIR EXHAUST DURING THE FILLING OF THE TANKER, PRIMARILY FOR DAIRY FARM PICK UP AT PUMP CAPACITIES AND SPEEDS UP TO 150 GPM. RUNOVENT ALLOWS BREATHING AND BAFFLES AGAINST SPILLAGE DURING OVER THE ROAD TRANSPORT. SIMPLE THREE PIECE CONSTRUCTION MAKES IT EASY TO CLEAN. MEETS FDA AND MOST SANITARIANS SPECS. FITS ANY STANDARD 3" SANITARY FITTING!**

55795	RUNOVENT COMPLETE	55798	CAP
55796	SLEEVE		
55797	BAFFLE		

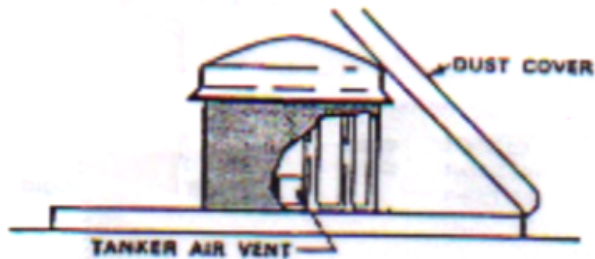

2" AIR FILTER  
DISC . PACKED  
100 PER BOX

# 45506

FILTERS FOR SCHWARTZ FILTER CELL. SLEEVE FILTER MEASURES 8 7/8" X 5 1/2" . PACKED 100 PER BOX.  
# 55852

SCHWARTZ FILTER CELL SUPPORT # 55850

**EASTERN CROWN HAS CLEANERS FOR YOU – THE BULK HAULER**

- **21GC** -- A NON-CHLORINATED GENERAL CLEANER. IT IS MORE EFFECTIVE THAN HARSH ALKALIS AND IT'S EASIER ON THE HANDS. #34046-34056
- **23CGC** -- THIS CLEANER IS CHLORINATED FOR MAXIMUM DETERGENCY. CLEAN WITH 23 AND WATCH SURFACES DRY BRIGHT AND FILM FREE!!! # 34058-34068
- **31PAC** – PHOSPHORIC AND NITRIC ACID. RESTORES OXIDE COATING ON STAINLESS STEEL TO MAKE IT NON-REACTIVE TO CORRODING ELEMENTS. # 34086-34096
- **33FAC** – THIS HIGH FOAM MANUAL ACID CLEANER IS HEAVY DUTY FOR FAST CLEANING ACTION! USED TO REMOVE MINERAL AND FILM DEPOSITS ON ALL SURFACES EXCEPT TIN AND ALUMINUM.
- **29MAC** – FOR CIRCULATING OF TANKS AND TANK TRUCKS. NON-FOAMING. CONTAINS 11.5% PHOSPHOROUS. USDA APP. FOR MEAT AND POULTRY PLANTS. # 34074-34084

# MILKHOUSE AND DAILY SUPPLIES

# ECI

TOLL FREE (877) 829 3505

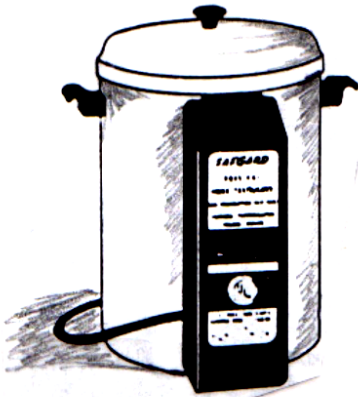

**THE ONLY HOME PASTEURIZER WITH PRESSURIZED HEATING AND VACUUM-SEALED COOLING!!** THIS ALLOWS FOR THE MAXIMUM IN BACTERIA DESTROYING EFFECT. THE VACUUM-SEALED COOLING KEEPS IN THE FLAVORS AND VITAMINS OF THE MILK. A RUGGED, HEAVY-DUTY THERMOSTAT CONTROLS THE TEMPERATURE, KEEPING IT BETWEEN 155 AND 159 DEGREES F. BUZZER SOUNDS AT THE END OF PASTEURIZATION.

**48075**

**SPECIAL ORDER ONLY**

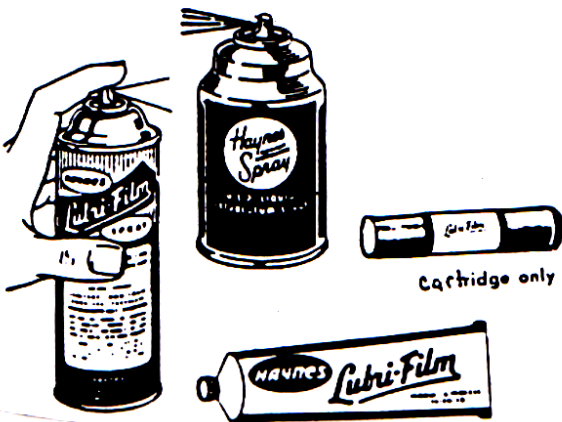

## SANITARY LUBRICANTS

- 41132 HAYNES TUBE "LUBRI-FILM" 12-4oz PER CTN.
- 41133 HAYNES SPRAY— Red can 6x9 oz PER CTN.  
Light Duty Sanitary Lubricating Spray
- 41134 HAYNES LUBRI-FILM—Blue can 6x11 ¼ oz  
Heavy Duty Sanitary Lubricating Spray
- 41135 12 x 12 oz cartridges per container

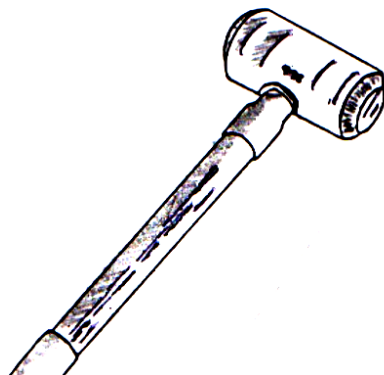

## PLASTIC MALLET – PLASTIC HANDLE

- UNBREAKABLE
- NON-CHIPPING
- NON-SLIP PLASTIC
- YELLOW IN COLOR

**# 48023-2**

**EASTERN CROWN, INC. SINCE 1947**





**FLOATING DAIRY THERMOMETERS – SHATTERPROOF**  
#41012 MEASURES 20 TO 220 degrees

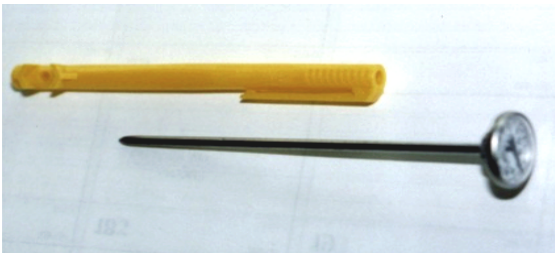

**Lintine Sediment Test Discs**  
#45504

Superior 1 ¼” discs, 100/bag

**Disc-mounted Sediment Test Card** #45512

A 2 ¼” x 6 1/8” card with filter media permanently mounted for fast, clean handling.

**GLASS POCKET CASE THERMOMETER #41028**  
IDEAL FOR READINGS WHERE THE LIGHT IS POOR  
Measures 0 to 220 degrees, Fits in your Pocket!



**# 41024**  
Precision Temperature Instrument for  
- Refrigeration  
- Air Conditioning  
- Food Service  
- Industrial  
- Laboratory  
- Automotive  
- General Purpose

**STAINLESS STEEL PIPE THERMOMETER**  
# 41006 I WOULDN'T SUGGEST USING THIS THERMOMETER ON THANKSGIVING DAY, BUT IT IS STURDY AND ACCURATE ENOUGH FOR A HOST OF DAIRY APPLICATIONS.



# MILK HANDLING HOSE

## SPIRALITE 170 FOOD HANDLING HOSE

This hose was redesigned in response to the call for better flexibility in cold temperatures. New since the spring of '99. Color is a clear wall with a white helix and smooth surface. Good in temperatures from - 10 to + 130 degrees F.

- 55813 3/4" ID x 1" OD
- 55799 1" ID x 1.25" OD
- 55800 1.25" x 1.50" OD
- 55802 1.5" x 1.84" OD
- 55804 2" x 2.37" OD
- 55805 2.5" x 2.90" OD
- 55806 3" x 3.46" OD
- 55811 4" x 4.53" OD

**SPIRALITE<sup>®</sup> 170**  
PVC STANDARD DUTY  
FOOD HANDLING  
SUCTION HOSE

- STANDARD LENGTH: 80'
- COLOR: Clear wall and white helix, smooth surface.
- TEMPERATURE RANGE: -10°F to + 130°F
- APPLICATION: Milk handling, food processing, conditions requiring see-through flow.
- HIGH QUALITY: High quality materials in compliance with the criteria of 3A Standard No. 20-00 and FDA. Acceptable to USDA for use federally inspected meat and poultry plants.

NOMINAL SIZE	inch	3/4"	1"	1 1/4"	1 1/2"	2"	2 1/2"	3"	4"	5"	6"	8"
APPROX. I.D.	inch	1.00	1.25	1.50	1.84	2.37	2.90	3.46	4.53	5.53	6.78	8.90
RECOMMENDED P.P. AT 80°F	psi	100	100	100	90	70	70	60	50	40	35	30
P.P. AT 140°F	psi	42	42	42	42	37	32	28	28	-	-	-
MINIMUM WATER AT 80°F	in./100	28	28	28	28	28	28	28	28	20	20	8
MINIMUM AIR FLOW RATE AT 80°F	inch	2	3	3	4	5	7	9	11	16	22	40
APPROX. WT. AT 80°F	lbs./ft.	20	24	28	44	66	88	123	187	232	309	504
APPROX. P.P. AT 140°F	psi	-	-	-	126	102	96	84	84	-	-	-

\*MIN. RADIUS FOR CONTINUOUS SERVICE

- COLOR: Clear, non-toxic F.D.A. recipe.
- STANDARD LENGTH: 1/2" - 300'
- TEMPERATURE RANGE: -10°F to + 130°F
- APPLICATION: Food processing, conditions requiring see-through flow.

NOMINAL SIZE	inch	1/2" x 3/4"	3/4" x 1"	1" x 1 1/4"	1 1/4" x 1 1/2"	1 1/2" x 1 3/4"	1 3/4" x 2"	2" x 2 1/2"	2 1/2" x 3"	3" x 3 1/2"	3 1/2" x 4"	4" x 4 1/2"
INSIDE DIAMETER	inch	33/32	49/32	33/16	49/32	49/32	1	1 1/8	1 1/4	1 1/2	1 3/4	2
WALL THICKNESS	inch	±.0128	±.0128	±.0128	±.0132	±.0132	±.0132	±.0132	±.0132	±.0132	±.0132	±.0132
OUTSIDE DIAMETER	inch	19/32	5/8	3/4	7/8	1-1/32	1-5/16	1-3/8	2	2-1/8	2-1/4	2-7/8
TOLERANCE	inch	±.0128	±.0128	±.0128	±.0132	±.0132	±.0132	±.0132	±.0132	±.0132	±.0132	±.0132
MAX. WORKING PRESSURE AT 80°F	psi	250	250	250	200	150	125	100	75	75	75	75
EXCESS BURST PRESSURE AT 80°F	psi	1000	800	800	800	600	500	400	300	300	300	300
APPROX. WT. lbs./100'		10.5	27	41	47	62	82	112	142	182	232	302

Acceptable to USDA for use federally inspected meat and poultry plants.

\*TOO LARGE FOR UPS

## SPIRALITE 410 PVC CLEAR BRAIDED HOSE

This hose is made from non toxic FDA recipe materials. Clear with white braids and smooth surface. Good from - 10 to + 130 degrees F. USDA approved for meat and poultry plants.

- ID x OD**
- 55803-1 3/8" x 5/8"
  - 55803 1/2" x 3/4"
  - 55800-1 3/4" x 1 1/32"
  - 55801 1" x 1 5/16"
  - 55799-1 1 1/4" x 1 3/4"
  - 55801-1 1 1/2" x 2"

## TRANSFLOW M-34R SANITARY RAW MILK TUBING



Transflow was the first tubing designed to meet the rigid requirements of raw milk handling. Identification is easy with a blue stripe embedded in the wall of the tubing and the name "Transflow M-34R Tubing" branded continuously along its length. Look for the blue stripe, it is your assurance of quality.

**SIZES: 1/2" 5/8" 9/16" 3/4" 7/8" 1" 1 1/2" 2" 2 1/2" and 3"**

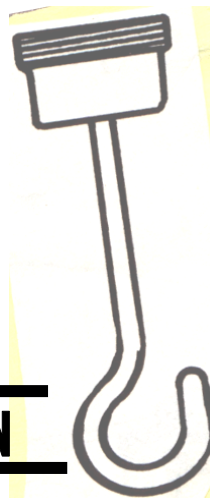
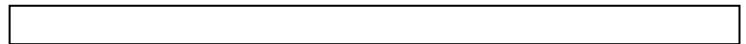

- S.S. HOSE PULL**
- #30261 For 1 1/2" hose
  - #30262 For 2" hose
  - #30263 For 2 1/2" hose
  - #30264 For 3" hose

**WE ARE EASTERN CROWN**

**SINCE 1947**

# MILKHOUSE AND DAILY SUPPLIES

CALL TOLL FREE  
(877) 829 3505

250 PSI

ALL METAL CONSTRUCTION SURROUNDED  
BY RUBBERIZED PLASTIC



# 30126

**WE  
CARRY  
ALL  
PARTS!**

## ALL PURPOSE NOZZLE

- Hot or Cold Water
- Leakproof
- Hold Open Clip

INV # 30134



## RAVEN HEAVY DUTY NOZZLE

# 30126-1 **NLA**

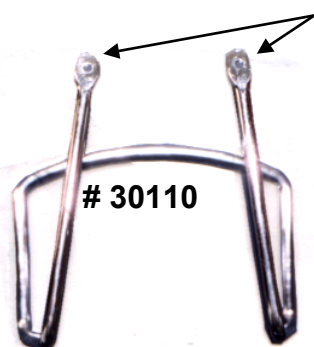

BOLTS TO  
MIXING  
VALVE

# 30110

## ECONO-FLEX RED COVER WATER HOSE



HOLDS 100'  
OF HOSE

# 30112



# 30096

5/8" hose – 200 lbs psi – 20 to 200 degrees F

# 30098

3/4" hose, 250lbs psi, 20-200°

### WATER SAVER NOZZLE WITH REPLACEABLE END

Bend it to get water, drop it or straighten it to shut the flow.

# 30124 For concentrated pressure  
30125 End Only

30128 Large Stream  
30129 End Only



**KEEP 'EM HIGH AND DRY!**

10 Prongs can't be wrong

465 RACK 30192

**UTORS OF DAIRY SUPPLIES SINCE 1947**

# MILKHOUSE AND DAILY SUPPLIES

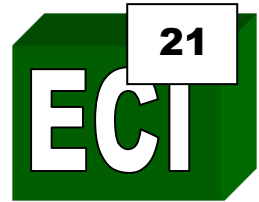

TOLL FREE  
(877) 829 3505



# 30084

- EVER-COOL CASE
- LIVE POWER SIGNAL
- AUTO SHUTOFF
- 16" x 15 1/2" x 13 1/4"
- ONE YEAR GUARANTEE
- 240 VOLT

WALL OUTLET FOR 240  
VOLT HEATER  
# 30085



# 30188

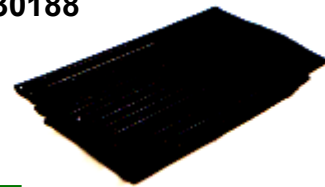

RUBBER MATS

- HEAVY GAUGE RUBBER
- 18" x 24"
- IDEAL FOR PROTECTING POLISHED SURFACES!

## MIXING VALVE

CONNECT TO TOP OR  
BOTTOM

# 30108

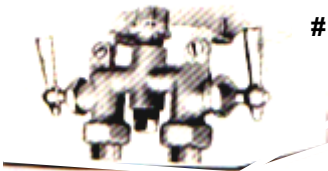

SPECIALLY DESIGNED  
TO MOUNT ON THE  
WALL, NOT IN THE  
WASH TANK, SO THE  
HANDLES TURN FREE.  
THE SPOUT IS  
THREADED SO A HOSE  
CAN BE ATTACHED

# 30104

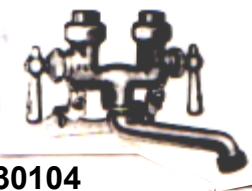

## CABINETS



SINGLE DOOR TWO  
SHELF CABINETS

- 15" x 10.5" x 22.5"

# 30156 Stainless Steel

30157 36 Heavy  
Gauge Steel

STAINLESS STEEL ANIMAL CARE CABINET

- REMOVABLE SHELF
- SELF CLOSING
- PRESSURE SENSITIVE MAGNETS
- DOOR OVERLAPS FOR DRYNESS

# 30165

EASTERN CROWN, INC. OFFERS UPS DELIVERY ON MOST ALL THE PRODUCTS  
SHOWN IN OUR CATALOG. PLEASE CALL FOR INFO ON SERVICE COMMITMENT.

**EASTERN CROWN, INC. DISTRIBUTOR OF DAIRY SUPPLIES SINCE 1947**



# APPLICATION AND REPORT FORMS

APPLICATION TO INSTALL A PIPELINE MEANS OR TRANSFER SYSTEM

1. This application is to be accompanied by a certified drawing showing the following: (a) High plan, (b) elevation, (c) cross-section, (d) plan or side view, or whatever section is necessary to show the location and construction of the pipeline system. Make a separate drawing for each section of the pipeline system.

2. The applicant is to be accompanied by a certified drawing showing the following: (a) High plan, (b) elevation, (c) cross-section, (d) plan or side view, or whatever section is necessary to show the location and construction of the pipeline system. Make a separate drawing for each section of the pipeline system.

3. The applicant is to be accompanied by a certified drawing showing the following: (a) High plan, (b) elevation, (c) cross-section, (d) plan or side view, or whatever section is necessary to show the location and construction of the pipeline system. Make a separate drawing for each section of the pipeline system.

4. The applicant is to be accompanied by a certified drawing showing the following: (a) High plan, (b) elevation, (c) cross-section, (d) plan or side view, or whatever section is necessary to show the location and construction of the pipeline system. Make a separate drawing for each section of the pipeline system.

5. The applicant is to be accompanied by a certified drawing showing the following: (a) High plan, (b) elevation, (c) cross-section, (d) plan or side view, or whatever section is necessary to show the location and construction of the pipeline system. Make a separate drawing for each section of the pipeline system.

6. The applicant is to be accompanied by a certified drawing showing the following: (a) High plan, (b) elevation, (c) cross-section, (d) plan or side view, or whatever section is necessary to show the location and construction of the pipeline system. Make a separate drawing for each section of the pipeline system.

7. The applicant is to be accompanied by a certified drawing showing the following: (a) High plan, (b) elevation, (c) cross-section, (d) plan or side view, or whatever section is necessary to show the location and construction of the pipeline system. Make a separate drawing for each section of the pipeline system.

8. The applicant is to be accompanied by a certified drawing showing the following: (a) High plan, (b) elevation, (c) cross-section, (d) plan or side view, or whatever section is necessary to show the location and construction of the pipeline system. Make a separate drawing for each section of the pipeline system.

9. The applicant is to be accompanied by a certified drawing showing the following: (a) High plan, (b) elevation, (c) cross-section, (d) plan or side view, or whatever section is necessary to show the location and construction of the pipeline system. Make a separate drawing for each section of the pipeline system.

10. The applicant is to be accompanied by a certified drawing showing the following: (a) High plan, (b) elevation, (c) cross-section, (d) plan or side view, or whatever section is necessary to show the location and construction of the pipeline system. Make a separate drawing for each section of the pipeline system.

Application to Install Pipeline # 45216 for NY # 45117 for Penn

DAIRY FARM SANITATION REPORT

1. GENERAL INFORMATION

2. SANITATION FACILITIES

3. CLEANLINESS

4. TOILET AND WATER SUPPLY

5. TOILET

6. CLEANLINESS

7. TOILET

8. TOILET

9. TOILET

10. TOILET

11. TOILET

12. TOILET

13. TOILET

14. TOILET

15. TOILET

16. TOILET

17. TOILET

18. TOILET

19. TOILET

20. TOILET

21. TOILET

22. TOILET

23. TOILET

24. TOILET

25. TOILET

26. TOILET

27. TOILET

28. TOILET

29. TOILET

30. TOILET

31. TOILET

32. TOILET

33. TOILET

34. TOILET

35. TOILET

36. TOILET

37. TOILET

38. TOILET

39. TOILET

40. TOILET

41. TOILET

42. TOILET

43. TOILET

44. TOILET

45. TOILET

46. TOILET

47. TOILET

48. TOILET

49. TOILET

50. TOILET

51. TOILET

52. TOILET

53. TOILET

54. TOILET

55. TOILET

56. TOILET

57. TOILET

58. TOILET

59. TOILET

60. TOILET

61. TOILET

62. TOILET

63. TOILET

64. TOILET

65. TOILET

66. TOILET

67. TOILET

68. TOILET

69. TOILET

70. TOILET

71. TOILET

72. TOILET

73. TOILET

74. TOILET

75. TOILET

76. TOILET

77. TOILET

78. TOILET

79. TOILET

80. TOILET

81. TOILET

82. TOILET

83. TOILET

84. TOILET

85. TOILET

86. TOILET

87. TOILET

88. TOILET

89. TOILET

90. TOILET

91. TOILET

92. TOILET

93. TOILET

94. TOILET

95. TOILET

96. TOILET

97. TOILET

98. TOILET

99. TOILET

100. TOILET

Dairy Farm Sanitation Report # 45115

DAIRY FARM INSPECTION REPORT

1. GENERAL INFORMATION

2. SANITATION FACILITIES

3. CLEANLINESS

4. TOILET AND WATER SUPPLY

5. TOILET

6. CLEANLINESS

7. TOILET

8. TOILET

9. TOILET

10. TOILET

11. TOILET

12. TOILET

13. TOILET

14. TOILET

15. TOILET

16. TOILET

17. TOILET

18. TOILET

19. TOILET

20. TOILET

21. TOILET

22. TOILET

23. TOILET

24. TOILET

25. TOILET

26. TOILET

27. TOILET

28. TOILET

29. TOILET

30. TOILET

31. TOILET

32. TOILET

33. TOILET

34. TOILET

35. TOILET

36. TOILET

37. TOILET

38. TOILET

39. TOILET

40. TOILET

41. TOILET

42. TOILET

43. TOILET

44. TOILET

45. TOILET

46. TOILET

47. TOILET

48. TOILET

49. TOILET

50. TOILET

51. TOILET

52. TOILET

53. TOILET

54. TOILET

55. TOILET

56. TOILET

57. TOILET

58. TOILET

59. TOILET

60. TOILET

61. TOILET

62. TOILET

63. TOILET

64. TOILET

65. TOILET

66. TOILET

67. TOILET

68. TOILET

69. TOILET

70. TOILET

71. TOILET

72. TOILET

73. TOILET

74. TOILET

75. TOILET

76. TOILET

77. TOILET

78. TOILET

79. TOILET

80. TOILET

81. TOILET

82. TOILET

83. TOILET

84. TOILET

85. TOILET

86. TOILET

87. TOILET

88. TOILET

89. TOILET

90. TOILET

91. TOILET

92. TOILET

93. TOILET

94. TOILET

95. TOILET

96. TOILET

97. TOILET

98. TOILET

99. TOILET

100. TOILET

NY Dairy Farm Inspection Report with Permit # 45190 CLOSE-UP VIEW

PRODUCER QUALITY CONTROL RECORD

1. GENERAL INFORMATION

2. SANITATION FACILITIES

3. CLEANLINESS

4. TOILET AND WATER SUPPLY

5. TOILET

6. CLEANLINESS

7. TOILET

8. TOILET

9. TOILET

10. TOILET

11. TOILET

12. TOILET

13. TOILET

14. TOILET

15. TOILET

16. TOILET

17. TOILET

18. TOILET

19. TOILET

20. TOILET

21. TOILET

22. TOILET

23. TOILET

24. TOILET

25. TOILET

26. TOILET

27. TOILET

28. TOILET

29. TOILET

30. TOILET

31. TOILET

32. TOILET

33. TOILET

34. TOILET

35. TOILET

36. TOILET

37. TOILET

38. TOILET

39. TOILET

40. TOILET

41. TOILET

42. TOILET

43. TOILET

44. TOILET

45. TOILET

46. TOILET

47. TOILET

48. TOILET

49. TOILET

50. TOILET

51. TOILET

52. TOILET

53. TOILET

54. TOILET

55. TOILET

56. TOILET

57. TOILET

58. TOILET

59. TOILET

60. TOILET

61. TOILET

62. TOILET

63. TOILET

64. TOILET

65. TOILET

66. TOILET

67. TOILET

68. TOILET

69. TOILET

70. TOILET

71. TOILET

72. TOILET

73. TOILET

74. TOILET

75. TOILET

76. TOILET

77. TOILET

78. TOILET

79. TOILET

80. TOILET

81. TOILET

82. TOILET

83. TOILET

84. TOILET

85. TOILET

86. TOILET

87. TOILET

88. TOILET

89. TOILET

90. TOILET

91. TOILET

92. TOILET

93. TOILET

94. TOILET

95. TOILET

96. TOILET

97. TOILET

98. TOILET

99. TOILET

100. TOILET

Producer Quality Control Record # 45103 Back of form has plate count or plate loop count, Antibiotics, WMT, DMSCC + 000, Electronic + 000, Temperature, (2 year record), 100 per pad



45060 10" x 14.5" Plastic Envelope with seal to protect sheets from moisture



## NITRILE DISPOSABLE GLOVES

WE CARRY POWDERED AND POWDER-FREE. IN SIZES FROM SMALL TO XXL

### NEW! Nitrile Disposable Gloves

- NO LATEX
- INSIDE POWDERED FOR EASY ON
- LONG WRIST COVERAGE

## RUBBER FROCK-LINED GLOVES



GREAT FOR PROTECTING HANDS DURING HARSH CHEMICAL APPLICATIONS. LOOK GOOD ON A MOTORCYCLE TOO!

- DOUBLE-DIPPED
- FULLY COATED BLACK PVC
- INTERLOCK LINED
- SANDY GRIP # 22050

## APRONS

# 41072  
Heat-sealed edges  
Standard duty  
White PVC



# 41064-1  
Double coated rubber  
on cotton  
Turned edges



## PLASTIC BOOTS WITH TIES

Here's just the boot you will need to prove to your farmer friends that you carry no disease from one farm to another. Slip on then dispose of. Made of heavy gauge Polyethylene. Fits all sizes of feet. 50 boots per pack.

# 48052



## DELVOTEST P SP/NT SP

Standard diffusion test for the determination of antibiotic residues in milk.

**42010** DELVOTEST P – 2 ½ hour test for antibiotics. Components of the test kit: 25 ampules containing bacillus stearothermophilus var. calidolactis in solid medium, 25 tablets containing nutrients based on glucose and indicator, dosing syringe for sampling milk, 25 disposable pipettes, tweezers, and complete instructions.

**42043** DELVOTEST SP/NT – 3 hour test for antibiotics. Tests for the same antibiotics as the Standard “P” Kit plus sulfa compound drugs. Components same as above.

**42020** DELVOTEST STARTER KIT

**42014** 8 well – 120 volt incubator

**42013** DELVOTEST thermometer

**42011** DELVOTEST SP/NT 100

CALL US FOR  
ALL YOUR  
TESTING

## SNAP TEST FOR ANTIBIOTICS

- 42050 20 TEST SNAP KIT
- 42052 100 TEST SNAP KIT
- 42058 SNAP STARTER KIT
- 42056 SNAP HEATER

The SNAP **Beta-Lactam** test from Idexx Laboratories gets you results in about 10 minutes and tests for Penicillin G, amoxicillin, ampicillin, ceftiofur and cephalixin.

Rely on SNAP tests for accurate, efficient residue testing, all on a single platform.

## CALIFORNIA MASTITIS TEST

**55056** CMT starter kit includes one pint of ready-to-use solution, paddle, and applicator top

**55060** CMT standard kit includes one pint of concentrate reagent, applicator bottle and paddle

**55063** 16 oz. ready-to-use reagent

**55064** 16 oz. concentrate

**55068** CMT paddle

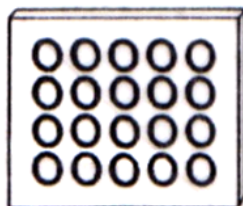

FLOAT-RAFT FOR  
SAMPLE VIALS



46089-24 24 HOLE VIAL RAFT

AVAILABLE IN 2 oz. and 3 oz.





### COOLERS FOR SAMPLES

#46078 NASCO sample ice chest designed especially for positive temperature control and proper protection of milk samples

#46079 34 qt. ICE CHEST

- LOW PROFILE
- STABLE DESIGN
- MOLDED-IN HANDLES

#46081 TOTE 12 COOLER  
This cooler is perfect for 14 and 15 dram vials.  
(use Texas raft 46095)



### SANITIZING TUBE - #46084

– For sample dipper and “Bob J” type dipper



### STAINLESS STEEL DIPPERS



### STAINLESS STEEL MILK STIRRER “PERFORATED” #47060

**SAMPLING STRAWS** Packed 25 straws per tube, 10 tubes per box

- 47036 12”, 120 tubes per case
- 47040 18”, 80 tubes per case
- 47044 24”, 60 tubes per case

### NASCO’S “WHIRL-PAK” BAG

- 46106 27 oz. clear
- 46108 2 oz. clear
- 46112 18 oz. clear
- 46116 6 oz. clear
- 46118 24 oz. clear
- 46123 36 oz clear

### “WHIRL-PAK” WITH WRITE-ON STRIP

- 46107 6 oz.
- 46115 16 oz.
- 46117 6 oz. bar with Thiosulfate tablet for water sampling

### STAINLESS STEEL DIPPERS



- # 47053 1 oz., 12”
- 47052 2 oz., 12”
- 47058 8 oz., 15”

# CLEANERS AND LAUNDRY

(877) 829  
3505



FARM BRAND  
PRODUCTS ARE

*“SUPERIOR PRODUCTS  
FOR THE  
AGRICULTURAL  
INDUSTRY.”*



## LAUNDRY PRE-SPOTTER

THIS PRODUCT IS A TERRIFIC SPOT REMOVER FOR CLOTHES, CARPETS OR UPHOLSTERY. IT IS STRONG ENOUGH TO CLEAN THE DIRTIEST OF HANDS, YET GENTLE ENOUGH TO REMOVE MAKE-UP AND MASCARA WITHOUT IRRITATING YOUR FACE. ENRICHED WITH ALOE VERA AND LANOLIN – IT HAS A GREAT FRAGRANCE TOO!

32710 12x1  
32712 ONE PINT

## CITRUS DEGREASER

CITRUS DEGREASER IS A  
TO PROVIDE A COMBINATI  
POWER. THE BUTYL COM  
SOLVENTS PROVIDE BOTH

32614 5 GALLON

NO LONGER  
AVAILABLE

D BUTYL, WHICH WORK TOGETHER  
USE, AND SERIOUS CLEANING  
G POWER, WHILE THE CITRUS  
SCENT.

## POWER CLEANER CONCENTRATE

REMOVES GREASE, GRIME, OIL, TAR, LIPSTICK, CRAYON MARKS, SMOKE FILM, HEEL MARKS, PENCIL MARKS, SHOE POLISH, ETC. I'VE EVEN USED IT TO UNCLOG A DRAIN! (NOT INTENDED FOR THIS USE, BUT ITS GREASE CUTTING IS IMPRESSIVE!)

32630 4x1 GALLON 32635 ONE QUART (SPRAY BOTTLE)  
32632 1 GALLON  
32634 12x1 QT. (SPRAY)

## CITRUS HAND CLEANER WITH PUMICE

NATURAL ORANGE IS A CITRUS HAND CLEANER AND CONDITIONER, IT IS BIODEGRADABLE, AND IT CONTAINS NO PETROLEUM SOLVENTS!!! SMELLS LIKE YOUR LOUNGING IN A GROVE OF ORANGES.

32660 4x1 GALLON 32662 GALLON  
32661 24x12 oz. 32661-1 12 oz.  
32728 6x12 oz.

## CITRUS HAND CLEANER WITHOUT PUMICE

32725 4x1 GALLON  
32726 GALLON

## HEAVY DUTY HAND CLEANER & CONDITIONER WITH PUMICE – FOR INDUSTRY!

32670 4x1 GALLON 32672 GALLON

## HEAVY DUTY HAND CLEANER & CONDITIONER WITHOUT PUMICE

32680 4x1 GALLON 32682 GALLON

**PLASTIC SPIGOT – FOR GREATER CHEMICAL RESISTANCE**

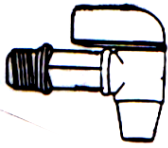

# 32239

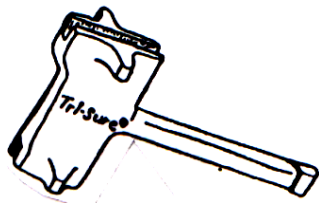

# 32243-1

**ALUMINUM WRENCH FOR PLASTIC DRUM PLUGS**

- EXTREMELY LIGHT
- SPECIALLY DESIGNED HEAD FOR PLASTIC DRUMS

**DRUM PUMPS FOR 5 GALLON CONTAINERS**

#32238 FOR DRUMS WITH 3/4" OPENING

32241

- FOR DETERGENTS, WAXES, ALKALIS, AND WATER
- WILL ALSO SIPHON
- 2" STANDARD ADAPTOR
- 18" OF CLEAR HOSE
- 1/2" VINYL TUBE REACHES BOTTOM OF 55 GAL. DRUM

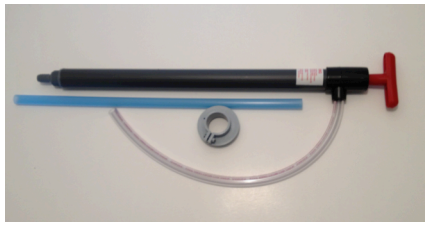
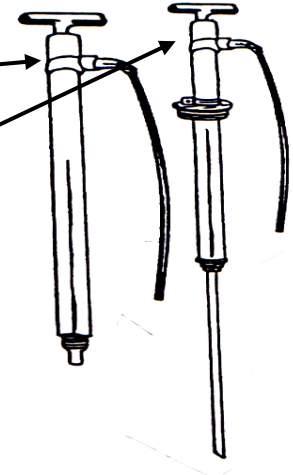

# 47049 # 47045

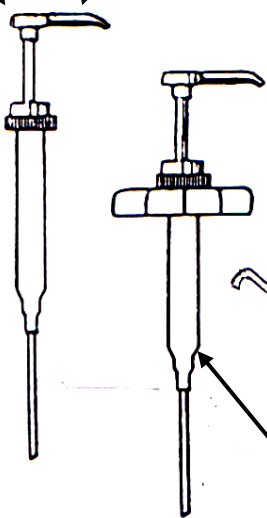

**MR50 32237**

- Self-venting
- No acid reaction
- Fits either 3/4" or 2"
- 360° pump orientation
- Dispenses in 2,4,6, or 8 ounce increments



MODEL# MR50



**DISPENSING PUMP FOR 1 AND 5 GALLON CONTAINERS**

47049 1 oz/38 mm cap, 10 3/4" tube "The 904"  
 47045 1/2" oz/38 mm cap, 10 3/4" tube  
 47047 70 mm cap and longer tube for 5 gallon Drum "The 905"

**MODEL MR60 32240**

For 15g and 55g drums. Polypropylene construction. Lever operated with a telescoping extension tube. Revolving spigot head.



# MILKHOUSE AND DAILY SUPPLIES

TOLL FREE  
(877) 829 3505

## INFLATION PLUG

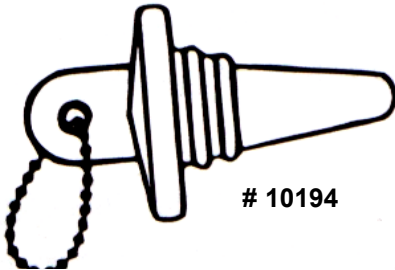

# 10194

FITS ANY SIZE INFLATION.  
RUBBER PLUG FOR SINGLE  
INFLATION SHUTOFF.

## STAINLESS STEEL SHUTOFF VALVE

# 55016

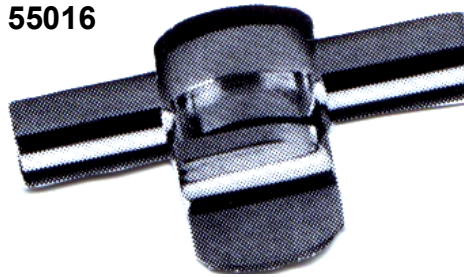

TOP O-RING 55015

TABBED FLAT  
WASHER # 55014

## CLOSURES

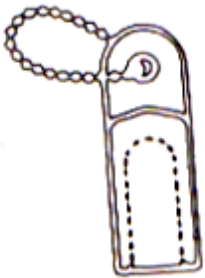

10443 11/16"

10442 9/16"

COVERS ENTIRE  
NIPPLE END –  
WITH CHAIN

- #55020
- #55018
- #55017

NON-VENTED  
VENTED  
O-RING

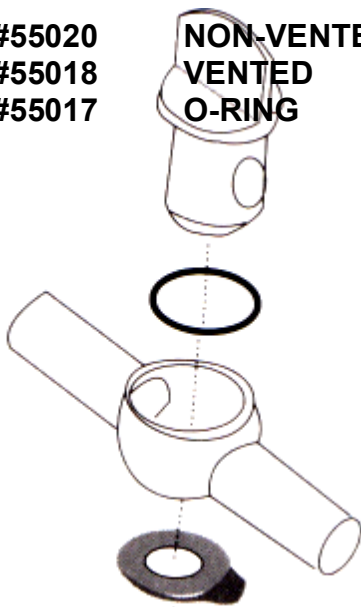

LEXAN SHUT-OFF VALVE  
WITH EXTERNAL O-RINGS  
AND STOPS

## PULSATOR OIL

EXTEND THE LIFE OF YOUR  
LEATHER! It has a clean odor –  
and will not gum or get sticky.  
12 per case.

# 55052 1/2 pint bottle



## VACUUM PUMP OIL

For either piston or rotary pumps. A  
nonfoaming oil that flows freely at low  
temperatures.

- 55043 1 gallon
- 55044 4x1 gallons
- 55045 5 gallon
- 55046 55 gallon drum

**NOW IN 2 1/2  
GALLON JUGS!**

# 55047

# MILKHOUSE AND DAILY SUPPLIES

TOLL FREE  
(877) 829 3505

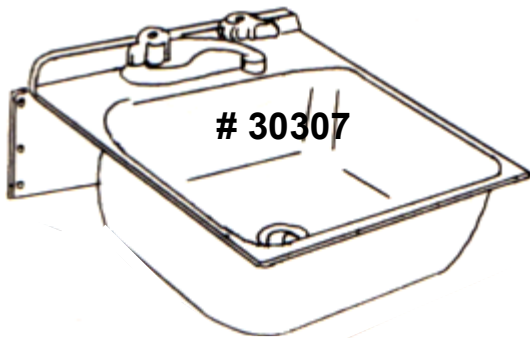
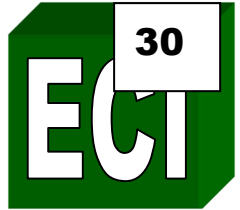

# 30307

## STAINLESS STEEL HAND WASH BASIN

Seamless bowl for easy cleaning. Comes with a 1 1/2" stainless steel drain, rubber stopper, and new all plastic faucet. Sink has a 6 quart capacity.

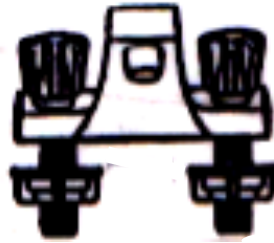

## FAUCET WITH LOCKING NUTS

# 30309

## THE SCRUBS YOU NEED



48000

JUMBO  
S.S.



#48005 Y/G  
#48007 GR/C  
#48011 GR/R  
#48013 WH/R

Rugged all steel construction, sturdy handrails, easy 57 1/2° climbing angle and "sure grip" tread make this ladder a great taskmaster. Can be shipped UPS.

# 30233

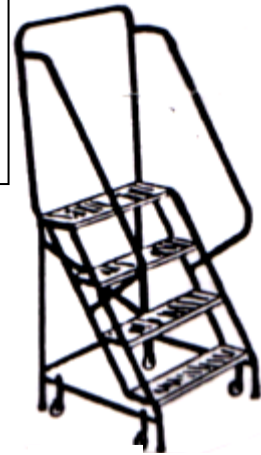

## STEEL ROLLING FOUR STEP SAFETY LADDER



STEP TO IT!

# 30184 1 step; 8" high

# 30180 2 step; 16" high

#30179 3 step; 27" high

## ALL LADDERS

ONE, TWO AND THREE STEP SAFETY LADDER

## ARE SPECIAL ORDER ONLY



**ALUMINUM LADDERS**

- Heavy duty master shelf
- Non-marring rubber bumper on top and bottom

# 30236 6 ft.  
30237 8 ft.



## STAINLESS STEEL BULK MILK TANK LADDER

6 FEET

# 30234

**WE ARE EASTERN CROWN, INC.**



# STAINLESS STEEL WASH AND RINSE TANKS

PLEASE SPECIFY LEGS OR WALL BRACKETS



**SIZES TO FIT  
ALL  
APPLICATION  
IN FARM OR  
PLANT!**

These tanks are made of 22-gauge, 18-8 type stainless steel. #28 finish, all inside tank corners have 1/2" radius; all joints are hellarch welded, which is a permanent leak-proof joint. No solder for cleaning material to dissolve. AVAILABLE IN ONE, TWO OR THREE SECTIONS. All sections 13 1/2" deep, 20 1/2" outside width, 18 1/2" inside width. The 23" inside sections have 22 GALLON CAPACITY; 29" section has a 28 GALLON CAPACITY. Drain assembly included.

- 30001 23" one section
- 30002 29" one section
- 30020 23" two section
- 30026 29" two section
- 30024 23" & 29" two section
- 30025 23" & 37" two section
- 30027 23" & 49" two section
- 30022 23" three section
- 30023 29" three section
- 30013 37" one section
- 30014 43" one section
- 30015 49" one section
- 30017 55" one section
- 30018 61" one section

## CLAW BRACKETS



Made of formed stainless steel

- 30038 For 23" or 24" tank
- 30039 For 29" or 30" tank

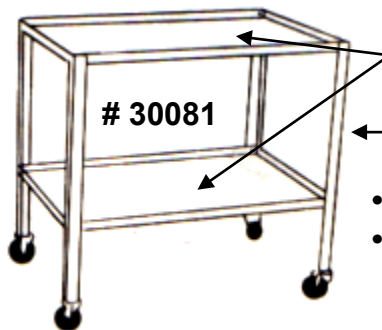

18 gauge S.S.

14 gauge S.S.

- 2 large 22" x 34" trays
- choice of swivel casters



- # 30304 Rubber Stopper
- 30305 Gasket
- 30306 Lock Nut
- 30028 Rubber Stopper # 3
- 30302 RC Cup Style Stopper

## TANK END TRAY # 30052

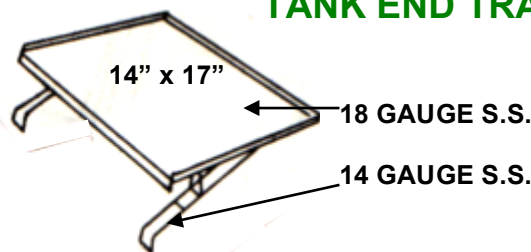

18 GAUGE S.S.

14 GAUGE S.S.

S.S. DRAINS # 30303

**DISTRIBUTOR OF DAIRY SUPPLIES SINCE 1947**

# SIX CYCLE AUTOMATIC CONTROLLER

**NLA**



**# 31046**

The stainless steel cabinet encloses hot-cold water hoses, fill hose, winding harness, drain assembly with mounting bracket, indicator.

EASTERN CROWN HAS MADE A COMMITMENT TO SUPPLY HARD-TO-FIND PARTS FOR MACHINERY USED IN AND AROUND THE DAIRY FARM. PLEASE CALL US IF YOU ARE LOOKING FOR A PART YOU DO NOT SEE IN THIS CATALOG. **(877) 829 3505**

**EXPLODED VIEW**

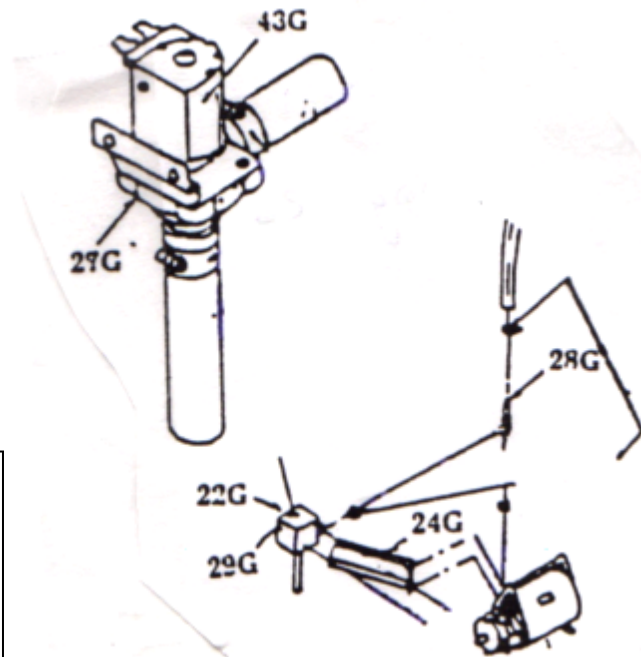
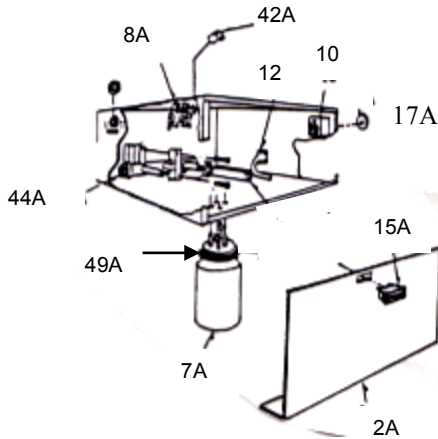

**AUTOMATIC CONTROLLER PARTS**

<b>1A</b>	<b>60946</b>	574930	<b>Shell, Control Box</b>
<b>2A</b>	<b>60948</b>	574411	<b>Cover, Control Box</b>
<b>4A</b>	<b>60910</b>	574357	<b>Assembly Valve – Ball Check</b>
<b>7A</b>	<b>60905</b>	575005	<b>Bottle (plastic)</b>
<b>8A</b>	<b>60952</b>	574262	<b>Mixing Valve (Hot and Cold Water)</b>
<b>10A</b>	<b>60930</b>	575013A	<b>Timer – W – 15D – 6</b>
*	<b>60900</b>	574637	<b>Gasket, Bottle</b>
<b>12</b>	<b>60958</b>	574798	<b>Pump, Solenoid Harness</b>
<b>15A</b>	<b>60925</b>	5761781	<b>Light, Indicator</b>
<b>17A</b>	<b>60962</b>	560447	<b>Knob, Timer</b>
<b>22G</b>	<b>60966</b>	6005451	<b>Solenoid Box</b>
<b>24G</b>	<b>60968</b>	574945	<b>Solenoid Box Bracket</b>
<b>27G</b>		5747490	<b>Drain Solenoid Valve</b>
<b>28G</b>	<b>60970</b>	574389	<b>Tee</b>
<b>29G</b>	<b>60972</b>	6005452	<b>Cover - Solenoid</b>

<b>31</b>	<b>61000</b>	574479	<b>Hose Inlet</b>
*	<b>60974</b>	574962	<b>Washer Hose Assembly</b>
<b>35</b>	<b>61004</b>	574799	<b>10' Cord to Pump Solenoid</b>
<b>42A</b>	<b>60980</b>	574401	<b>Coil – Hot and Cold Water Valve 110V</b>
<b>43G</b>	<b>60998</b>	574960	<b>Coil – Drain Valve 110V.</b>
<b>44A</b>	<b>60984</b>	588020	<b>Manifold Assembly</b>
<b>49A</b>	<b>60990</b>	588027	<b>Cap Assembly</b>
*	<b>60907</b>	5750055	<b>Det. Jar – Glass/Plastic Coated</b>
*	<b>60931</b>	5750135M	<b>115V Stator Mtr. For Time</b>
*	<b>60931-1</b>	5750135M	<b>230V Stator Mtr For Timer</b>
*	<b>61001</b>	575021	<b>220V Coil-Mixing Valve</b>
*	<b>61003</b>	5750135	<b>220V Timer</b>
*	<b>61005</b>	575022	<b>230V Coil Drain Valve</b>
*			<b>NOT ILLUSTRATED</b>



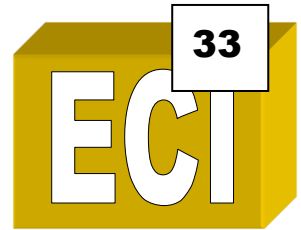

## PIPELINE WASHER: COMPLETE AND PARTS

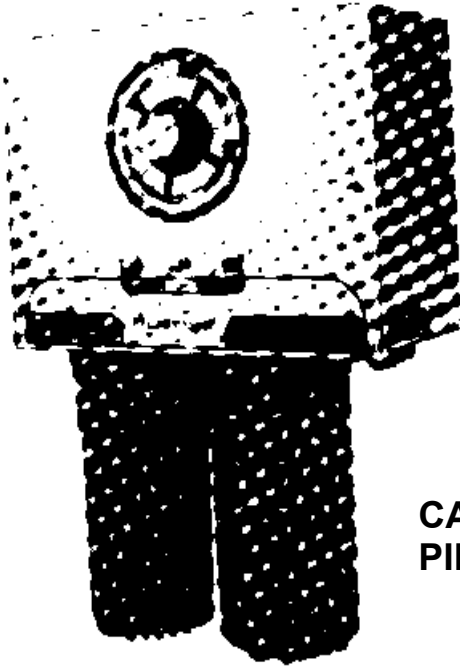

### ECI AUTOMATIC PIPELINE WASHER

Easily installed, easily maintained. Attractive styling. Control mounts on wall away from water vapor and fumes. It features an extended "vacuum" drying cycle for more complete drying. Our pipeline washer also features an extended "drain" period for those larger farms that may have longer pipelines. "Normally Open" drain valve for complete draining. Drain solenoid mounts under wash tank out of the way. **Our unit can be disassembled almost completely using only your hands.** Acid and detergent jars are heavy duty, unbreakable, air tight and easy to handle. Repair and maintenance are a breeze. Eastern Crown, Inc. carries a full line of parts as well. **# 31000**

CALL FOR A PARTS CATALOG FOR THE ECI  
PIPELINE CLEANER (877) 829 3505

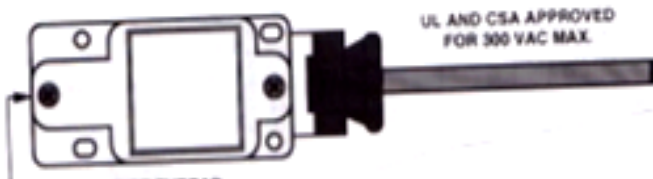

1/2" Pipe thread

UL AND CSA APPROVED  
FOR 300 VAC MAX.

### SAFETY SWITCH # 60849

For use with automatic pipeline washing systems to insure the discharge line from the receiver is properly placed for both milking and washing.

### MOTORIZED DRAIN VALVE COMPLETE # 30994-3

- WORKS WITH MOST AUTOMATIC PIPELINE SYSTEMS
- ALLOWS FULL FLOW DRAINING WITH WASH SOLUTIONS

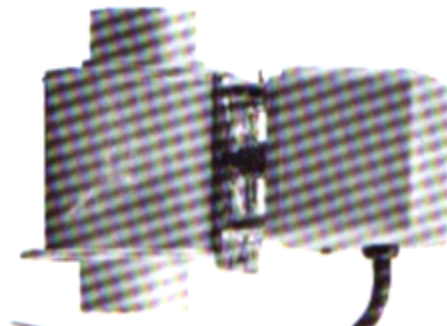

## SAVE UP TO 50% ENERGY REQUIREMENTS

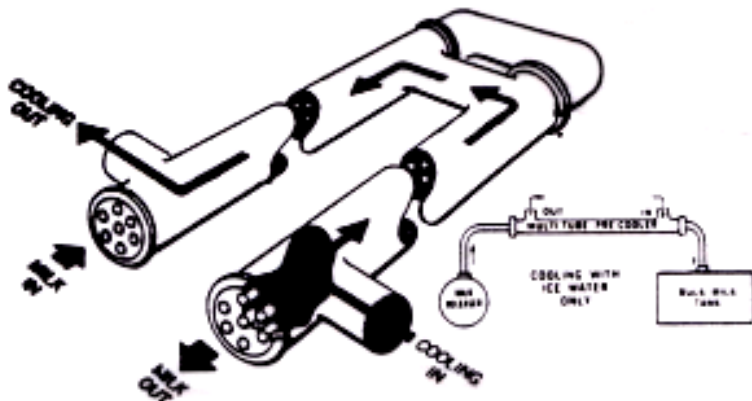

**MULTI-TUBE STAINLESS STEEL PRE-COOLING WITH WELL WATER** saves up to 50% of your energy requirements by using the coldness of well water to cool your milk.

Your bulk tank can store more milk because fresh milk enters at a lower temperature.

All water warmed in cooler can and should be used for everyday farm needs.

Pre-warmed water for hot water supply.

Watering cows.

Washing udders.

Flush tanks.

## DOES NOT WASTE WATER!

### MULTI-TUBE STAINLESS STEEL PRE-COOLER

#### HAIRPIN TYPE PRE-COOLER

55094 - 20 FT hairpin, 11' long with 7 tubes

55096 - 20 FT hairpin, 11' long with 4 tubes

#### STRAIGHT TYPE PRE-COOLER

55095 - 20 FT straight w/ 7 milk tubes

55098 - 30' straight w/ 7 milk tubes

# SPECIAL ORDER ONLY



#### FILTERED INTAKE-EXHAUST DUCT

These ducts can be used to draw cool air into the milkhouse or exhaust hot air. Uses an EZ-KLEEN filter.

		<u>FILTERS</u>	<u>SCREENS</u>
30542	15" x 24"	30546	30550
30543	15" x 32"	30549	30551
30545	15" x 40"	30547	30552

## PROTECT YOUR HOSE!

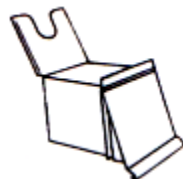

# 30228 For a six foot wall

# 30232 An 8 ft wall

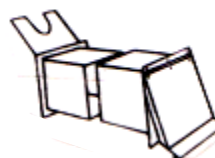

TELESCOPIC HOSE CHUTE IS EASY TO INSTALL AND COVERS ALL WALL THICKNESSES. ITS GALVANIZED.

#30256 - 4' TO 9' WALL

# 30260 - 8' TO 15' WALL

## STAINLESS STEEL TOTE PAIL

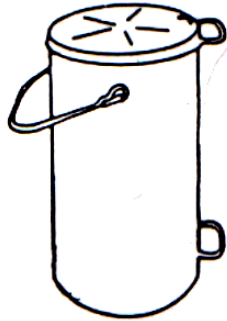

- TUBULAR DESIGN
- SEAMLESS S.S.
- TRIPLE THICK BOTTOM

# 33164  
33167 COVER ONLY

## STAINLESS STEEL PAIL COVERS

# 33184 12 1/4"

33192 13 1/8"

33200 14 5/8"



MEASUREMENT  
INDICATES  
DIAMETER

## STAINLESS STEEL MILK STRAINER



33072 NLA

USES 6 1/2" FILTER DISC

## TAPERED STAINLESS STEEL PAIL



33181 13 QUART

33189 16 QUART

33198 20 QUART

33180 13 QT W/CHIME

33190 16 QT W/CHIME

33196 20 QT W/CHIME

\* LATTER THREE ARE 13  
GAUGE STAINLESS

## ALUMINUM MILK KETTLE



- 20 GAUGE AL
- HIGHLY POLISHED OUTSIDE
- NATURAL INSIDE
- STURDY BALL HANDLE

33024 1 QUART

33028 4 QUART

## PLASTIC PAIL

- HEAVY DUTY POLYETHYLENE
- EXTRA STRONG RIM AND HANDLE FOR USE ON THE FARM

**33008**

CHECK OUT THE LAUNDRY PRE-SPOTTER AND CITRUS DEGREASER

CALL US TOLL FREE  
**(877) 829 3505**

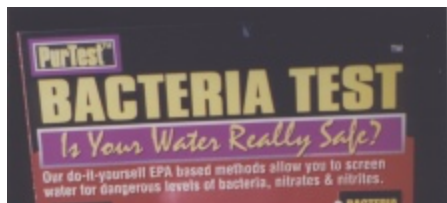

**NO LONGER AVAILABLE**



- EASY
- RELIABLE
- ACCURATE
- TESTS FOR BACTERIA, NITRATE, NITRITE

## TEST WATER HARDNESS

# 30202

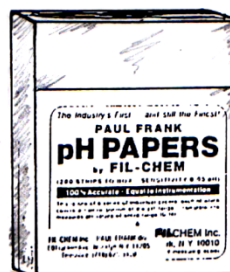

CHLORINE LITMUS PAPERS — 100 STRIPS PER TUBE **31178-2**  
IODINE LITMUS PAPERS — 100 STRIPS PER TUBE **31178-1**

TEST PH RANGE OF 9 TO 14 WITH THESE HANDY TESTING PAPERS—200 PER **# 31179-3**

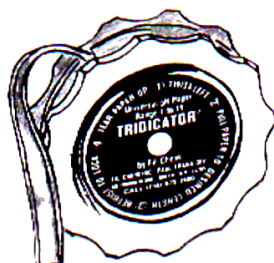

**TRIDICATOR—3 COLOR PH TEST PH RANGE 1-11 # 31179-2**



### SANI-GUIDE SANITARY PIPELINE INSERTS

A PLASTIC GASKET WITH A SPECIAL SYNTHETIC SCREENING MATERIAL ATTACHED TO IT. IT WILL CATCH HAIR, INSECT PARTS AND FOREIGN MATERIAL ELECTROSTATICALLY. ALSO PROTECTS PUMPS FROM DAMAGE.

49000 1 1/2" 49004 2"  
49008 3" 49010 SANI-GUIDE PLASTIC BAGS 1000 PER CASE

## PH HYDRION PAPERS

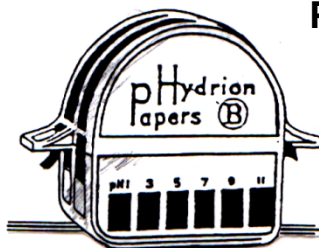

31178-4 TESTS PH OF 3.5--5.5  
31178-3 TESTS PH OF 1--11  
31178-6 TESTS PH RANGE—QUATERNARY AMMONIA 100--400

**EASTERN CROWN, INC. SINCE 1947**

# MILKHOUSE AND DAILY SUPPLIES

TOLL FREE  
(877) 829 3505

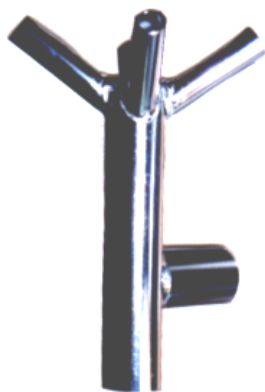
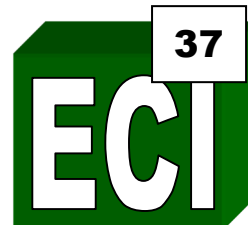

# 31196

## JETTER MANIFOLD

**WORKS WITH ALL  
JETTER CUP SIZES!**



SAFETY LIGHT

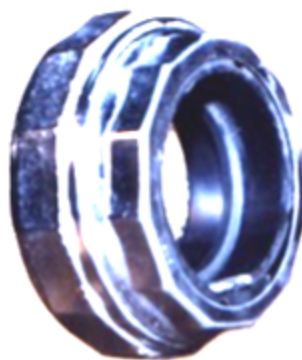

## GLASS PIPELINE COUPLER # 30894

- 30893 FEMALE UNION
- 30898 MALE UNION
- 30897 LOCKING RING
- 30896 COUPLING RING
- 30895 RUBBER GASKET

## JETTER CUP

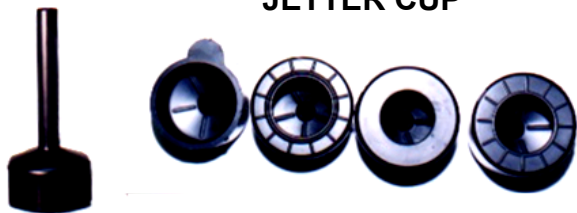

- # 10437 1 1/2" opening/flat top for DeLaval and most others
- # 10439 1 9/16" opening/flat top for Boumatic
- # 10440 For Surge
- # 10441 For DeLaval 1 3/8"

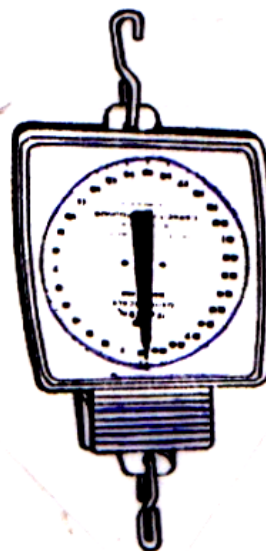

## 60 LB. DAIRY SCALE

- EASY-TO-READ
- 1/10 LB GRADUATION
- ADJUSTS TO DEDUCT CONTAINER WEIGHT

# 55069

THE VAST MAJORITY OF PRODUCTS OFFERED BY EASTERN CROWN, INC. CAN BE SHIPPED VIA UPS. WE SPECIALIZE IN GETTING YOU WHAT YOU NEED WHEN YOU NEED IT. THAT'S WHY WE'VE BEEN AROUND FOR MORE THAN 65 YEARS.



## 7540 DIVERTER VALVE PARTS LIST

CALL FOR INFORMATION ON PARTS NOT LISTED HERE. (877) 829 3505

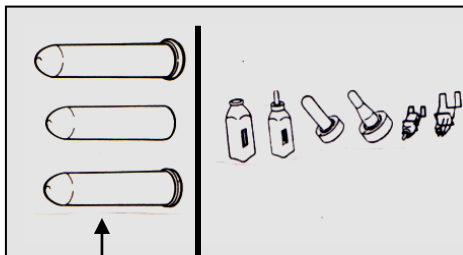
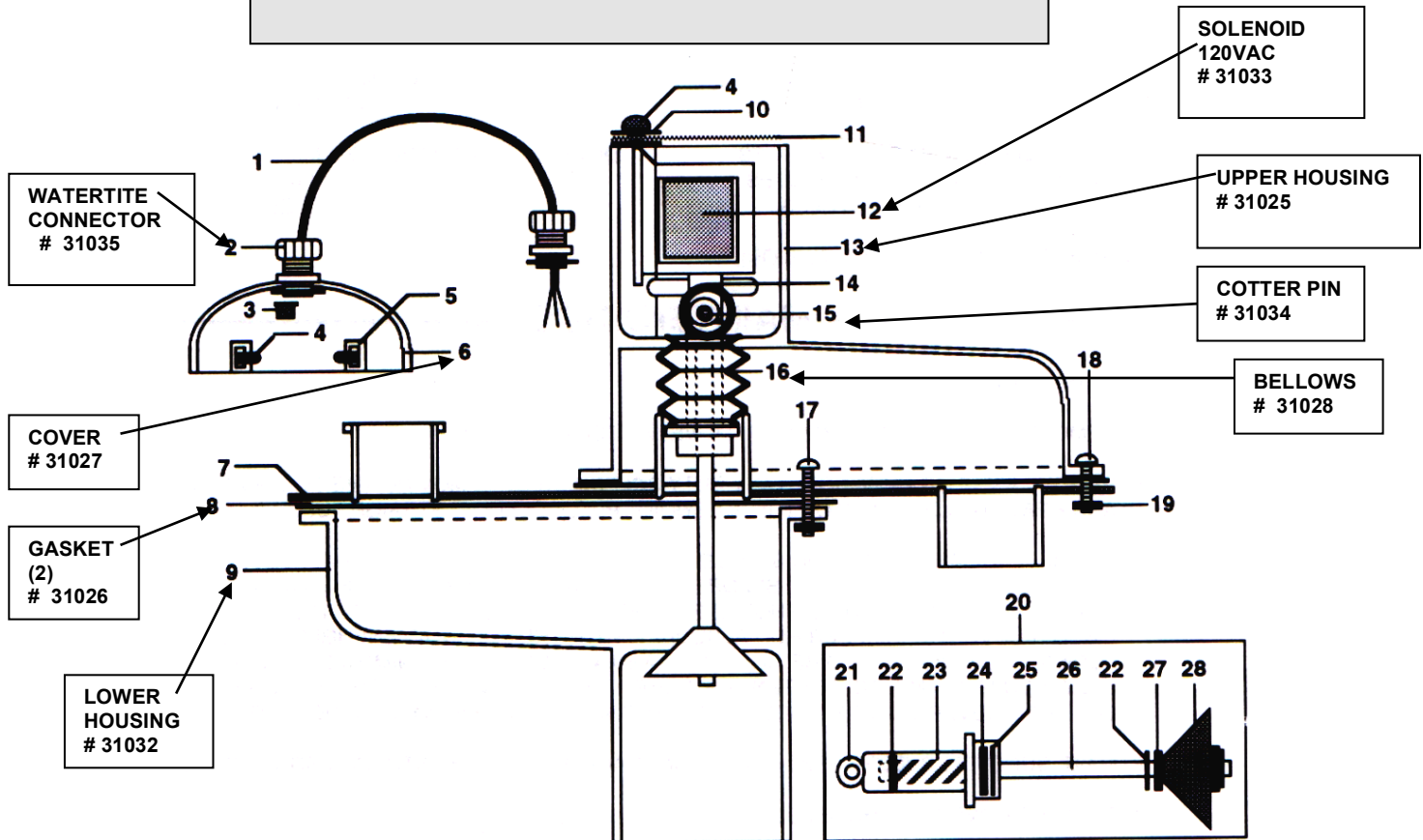

### REPLACEMENT CALF FEEDER NIPPLES

Quality, pure white rubber replacement calf feeder nipples. The CN3½E nipple also fits regular Coke bottles for feeding medicines.

# 10200 For General Pail      10208 For Coyner Pail  
# 10204 For Calftera Pail

**CALF PAIL VALVES**  
# 10212 Plastic valve with O-ring and nut  
10216 O-ring  
10220 Nut

- |    |                     |         |
|----|---------------------|---------|
| 20 | STOPPER ROD ASS.    | # 31029 |
| 21 | BUSHING             | 60837   |
| 22 | EXT. RETAINING RING | 60843   |
| 23 | SPRING              | 60847   |
| 24 | SPACE WASHER        | 60839   |
| 25 | INT. RETAINING RING | 60841   |
| 26 | STOPPER ROD         | 60845   |
| 27 | WASHER              | 31031   |
| 28 | STOPPER PLUG        | 31030   |

## 1800 WASHER-RELEASER

30762	1205 CYLINDER GASKET
30776	1107D STAINLESS STEEL CLIPPER PINS
30778	707F GUIDE ROD WEIGHT
30779	708 O-RING
30780	1009 PLASTIC CAP FOR 5/8" NIPPLE
30782	1023 FLOAT
30800	1364 RESTRICTOR, ADJUSTABLE
30804	1162 IN-LINE DISCHARGE VALVE ASS. EMBLY
30806	1162-A DISCHARGE VALVE HOUSING
30808	1162-B DISCHARGE VALVE INSERT
30810	1056-A DISCHARGE VALVE BALL
11120-1	MTE DISCHARGE VALVE EXT. TUBE
30830	1200-A VACUUM ASS. SCREW
30831	1200-B VACUUM ASS. SCREW
30832	1201 VALVE GUIDE BLOCK
30840	1108 TOP CAP
30842	1259 BOWL NIPPLE GASKET
30846	1207 VALVE HEAD AND ROD ASS.
30848	1207A GUIDE ROD ONLY
30850	1107B VALVE HEAD WITH FACE
30852	1107C RUBBER VALVE FACE
30854	1207D U CLIP
30856	507E GUIDE ROD TRIP SPRING
30860	1280 CHECK VALVE FOR 1" ID FLANGED LINE
30872	1283 CHECK VALVE FOR 1 1/2" ID FLANGED LINE
30880	1285 CHECK VALVE FOR 5/8" ID PLASTIC TUBING
30883	1286 CHECK VALVE FOR 3/4" PLAS. TUBING

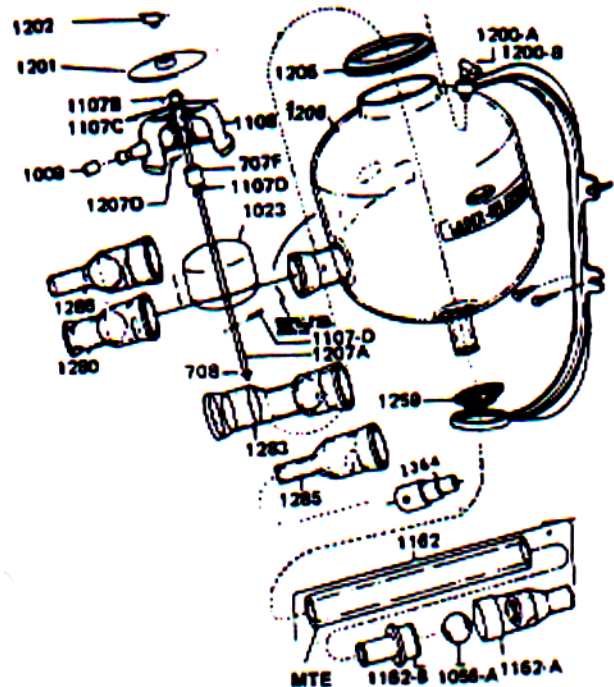

## 1600 WASHER-RELEASER

30752	1001 VALVE GUIDE BLOCK ASSEMBLY
30758	B-1002 WALL BRACKET
30760	100B TOP CAP W/ DEFLECTOR BAFFLE, NIPPLE
30762	1205 CYLINDER GASKET
30766	1085 BOWL NIPPLE GASKET
30768	707 VALVE HEAD AND GUIDE ROD ASSEMBLY
30770	707A GUIDE ROD ONLY
30772	707B VALVE HEAD WITH FACE
30774	707C RUBBER VALVE FACE
30776	1107D STAINLESS STEEL CLIPPER PIN
30778	707F GUIDE ROD WEIGHT
30779	708 O-RING
30780	1009 PLASTIC CAP FOR 5/8" NIPPLE
30782	1023 FLOAT
30788	1080 CHECK VALVE COMPLETE
30790	1081 CHECK VALVE T HOUSING
30792	1080B CHECK VALVE BALL
30794	1080D CHECK VALVE STEP NIPPLE
11120-1	MTE CHECK VALVE CONNECTOR TUBE
"	MTE DISCHARGE VALVE EXTENSION
30800	1364 RESTRICTOR, ADJUSTABLE
30804	1162 IN-LINE DISCHARGE VALVE ASSEMBLY
30806	1162A DISCHARGE VALVE HOUSING
30810	1056A DISCHARGE VALVE BALL

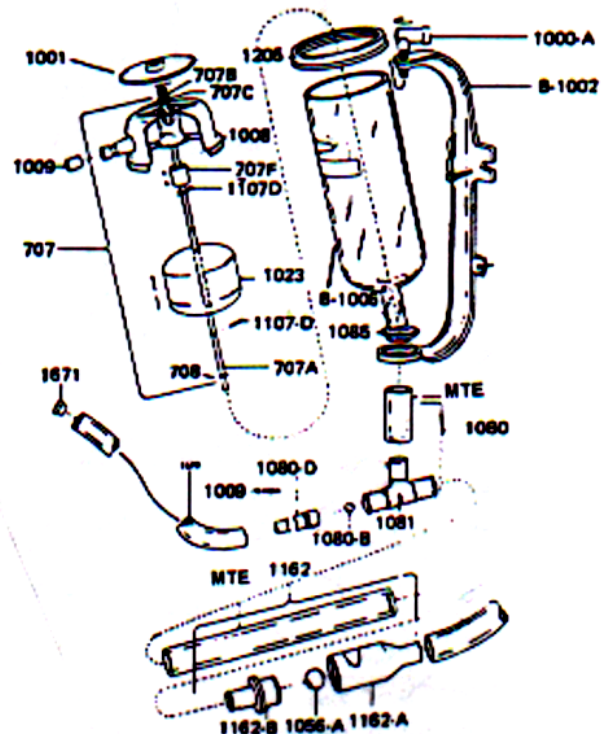

## PARTS FOR THE SPIN-EASY 1/2 H.P. PUMP AND MOTOR

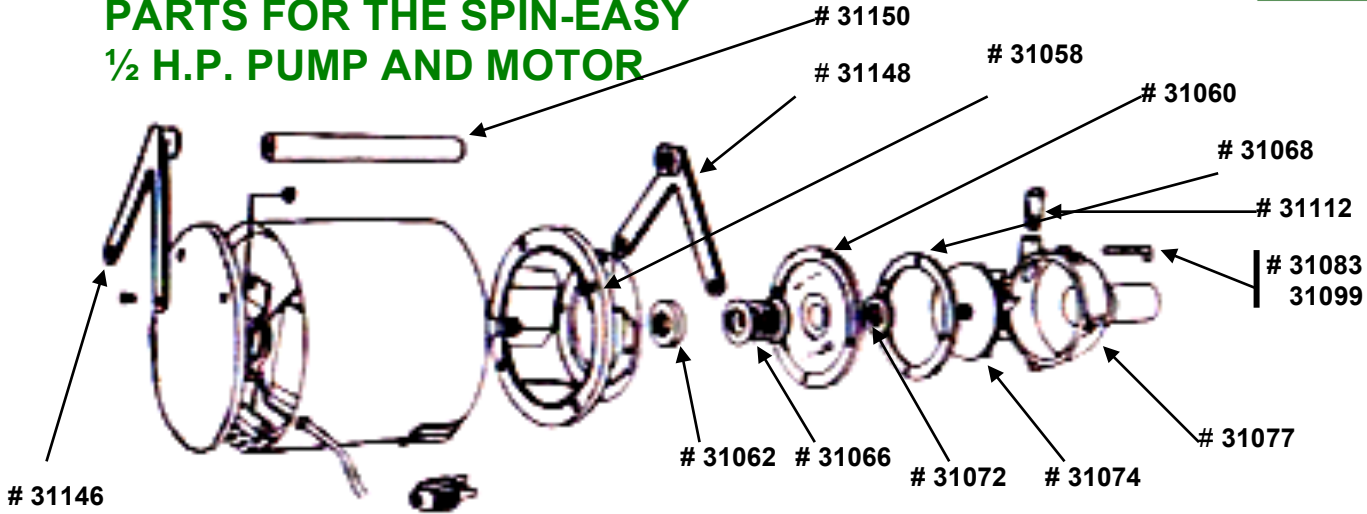

**EASTERN CROWN, INC. ALSO CARRIES PARTS FOR THE 1 HP PUMP NOT PICTURED HERE. CALL (877) 829 3505 FOR INFO**

- 31146 BACK HANDLE BRACKET
- 31150 HANDLE BUSHING
- 31148 FRONT HANDLE BRACKET
- 31062 MOTOR SHAFT COLLAR
- 31066 SHAFT SEAL
- 31058 PUMP BACK PLATE ONLY
- 31060 S.S. INSERT ONLY
- 31068 PUMP HOUSING GASKET
- 31072 S.S. IMPELLER SPACER
- 31074 IMPELLER
- 31077 PUMP HOUSING
- 31112 1/2" NIPPLE ONE END THREAD.
- 31083 S.S. BOLT HOOK WITH NUT
- 31099 1/2 PUMP MOTOR ONLY

## PARTS FOR SPINNER

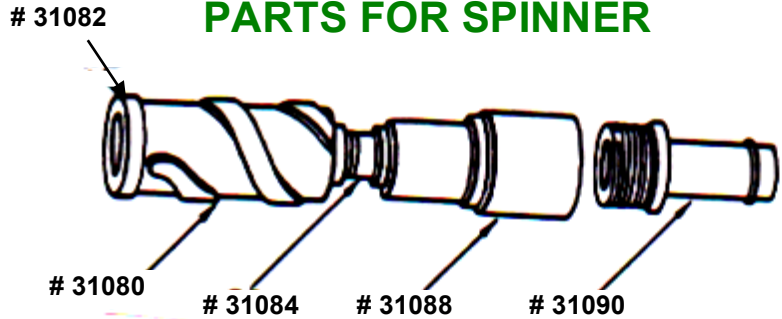

- 31080 SPINNER HOUSING
- 31082 SPINNER END CAP
- 31084 SPINNER PISTON
- 31086 SPINNER WASHER
- 31088 SPINNER CYLINDER
- 31090 3/4" SPINNER HOSE ADAPTOR
- \*31092 9/16" SPINNER HOSE ADAPTOR

## L.C. THOMSEN PUMP PARTS

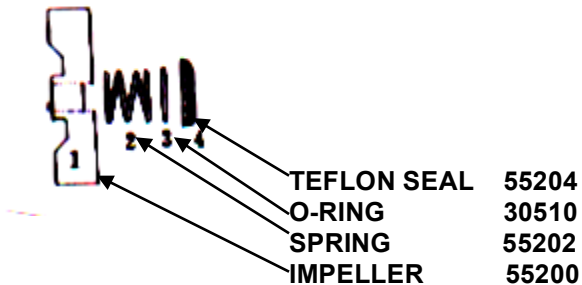

- TEFLON SEAL 55204
- O-RING 30510
- SPRING 55202
- IMPELLER 55200

## BULK TANK COVERS



- 30520 COVER ONLY
- 30537 COVER WITH 1 1/2" HOLE
- 30538 COVER WITH 1 1/2" HOLE AND CLIP

# SAN SPRAY PARTS

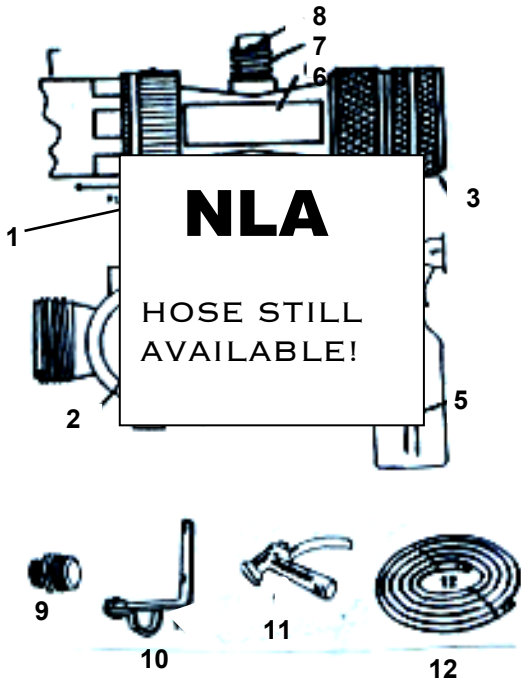

1	30676	24012	Meter Head Only. Type 2 for Cl.
	30680	24013	Meter Head Only. Type 5 for Acid.
2	30684	24029	Hypalon Gasket (Head Gasket)
3	30688	24010	Swivel Connector
4	30692	40086	16 oz. Bottle (glass)
4	61120	92198	16 oz. Bottle (plastic)
5	30696	24017	Suction Tube
6	30697	24024	O ring Set 2 (1 large, 1 small)
7	30698	24027	Valve Spring
8	30699	24028	Cotter Pin
9	30740	24011	Thread Conversion Nipple
10	30744	24021	Hose Bracket
11	30132	573C	Spray Nozzle
	30700	24002-2	Metering Unit w/Bottle, Swivel Connector, Suction Tube, Type 2 Head
	30704	24002-5	Same as 24002-2 except 5 Head
	30708	24033	Repair Kit for Meter Head Includes Suction Tube, O Rings, Valve Springs SS Valve Cotter Pins, Head Gasket, Bottle, Hose Gasket, San Spray Solution Hose with Fittings Both Ends

**SAN SPRAY HOSE HAS WATER HOSE FITTINGS ON BOTH ENDS**

# 30716	6'	30728	20'
30732	25'	30720	10'
30736	30'	30724	15'

**EASTERN CROWN, INC. ALSO CARRIES PARTS FOR LONN TYPE A, B AND C SPRAYERS. CALL FOR A CATALOG AND PARTS LIST. TOLL FREE (877) 829-3505.**



**LUMACO S.S. OUTLET VALVES AND PARTS**

61160	RLR 1 1/2" THREADED TYPE
61182	RMP 1 1/2" CLAMP TYPE
61183	RLR 2" THREADED TYPE
61184	RMP 2" CLAMP TYPE
61185	13HRL 1 1/2" S.S. NUT
61186	13HRL 2" S.S. NUT
61193	135010/7R 1 1/2" BUNA N SEAT - CLAMP TYPE
61194	150010/7R 2" BUNA N SEAT - CLAMP TYPE
61195	1 1/2" BUNA N SEAT THREADED TYPE
61196	2" BUNA N SEAT THREADED TYPE
61197	135013/7 1 1/2" BUNA N O-RINGS
61198	150013/7 2" BUNA N O-RINGS
61201	HANDLE FOR ALL VALVES ABOVE

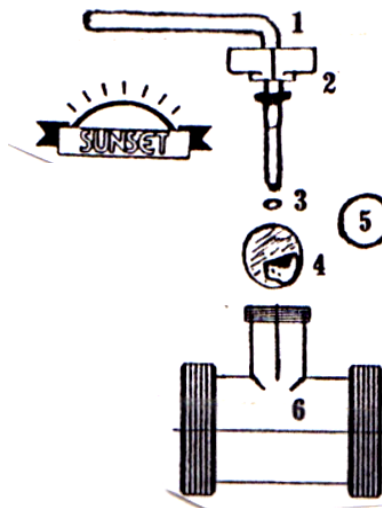

**SUNSET S.S. OUTLET VALVE PARTS**

# 61141	VALVE HANDLE
61142	VALVE HANDLE NUT
61143	SMALL O-RING
61144	VALVE DISC
30510	O - RING
61145	VALVE BODY



# SPRAYERS FOR FARM AND INDUSTRY



CALL (877) 829 3505



## DUAL UNIT SPRAYER WITH ONE HOSE

### A THREE OPERATION SPRAYER WITH ONLY ONE HOSE!

VALVED SYSTEM ALLOWS YOU TO SPRAY PLAIN WATER OR A SANITIZED SPRAY BY OPENING ONE OF THE BOTTLE SHUTOFFS. SAN SPRAY ASSEMBLIES COMBINE ONE OR MORE OF "PENTON" PLASTIC, NON-CORRODABLE, HIGHLY ACCURATE CHEMICAL METERING UNITS WITH A DURABLE, SMOOTH WALL RUBBER HOSE 15' LONG AND A SPECIAL CORROSION RESISTANT SPRAY NOZZLE. Type 2 nozzle mixes 1 oz. of solution per 2 gallons of water (usually chlorine); Type 3 mixes 1 oz. per 5 gallons of water (usually acid).

- 30656** 24000-25 with one #2 and one #5 head
- 30666** 24000-22 with two #2 heads
- 30664** 24000-55 with two #5 heads

CALL FOR AVAILABILITY



#30560

## SINGLE UNIT SPRAYER WITH TWO HOSES. WATER PRESSURE OPERATED

Spraying parts are stainless steel. A set of regulating inserts allows you to customize your mix to fit your application. A Y fitting is the centerpiece of this workhorse.

## SINGLE UNIT SPRAYER WITH ONE HOSE, WATER PRESSURE OPERATED

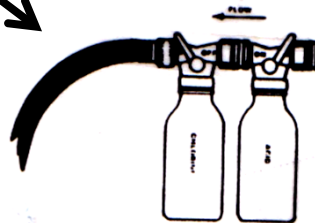

A San Spray Unit same as above, but with one metering head for use when only one chemical solution is needed.

- # 30668** 24001-2 with one #2 head
- # 30672** 24001-5 with one #5 head

# 30568

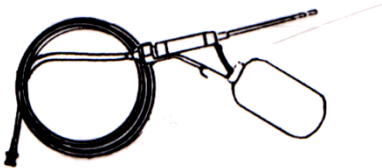

## SINGLE UNIT SPRAYER WITH ONE HOSE #30568

THIS WATER PRESSURE OPERATED UNIT IS A SINGLE PURPOSE SPRAYER FOR SANITIZING ONLY. SPRAY PARTS ARE STAINLESS STEEL.

## COMPRESSED AIR OPERATED FOG GUN

**SPECIAL ORDER ONLY**



LOWN AIR PRESSURE OPERATED GUN FOR FOGGING INTERIOR OF MILK STORAGE TANKS. SPRAYING PARTS ARE STAINLESS STEEL.

- # 30572** Fog Gun Only. Specify 6' hose or 1 quart plastic bottle
- # 30574** 6' Siphon Hose Only for Fog Gun
- # 30652** XF 1 qt. Plastic Bottle for Fog Gun
- # 30994-1** APW Gasket

**EASTERN CROWN, INC.**



## PARTS FOR VACUUM OPERATED AUTOMATED TEAT SPRAY

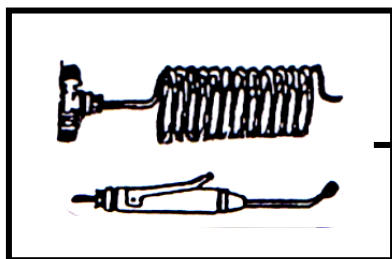
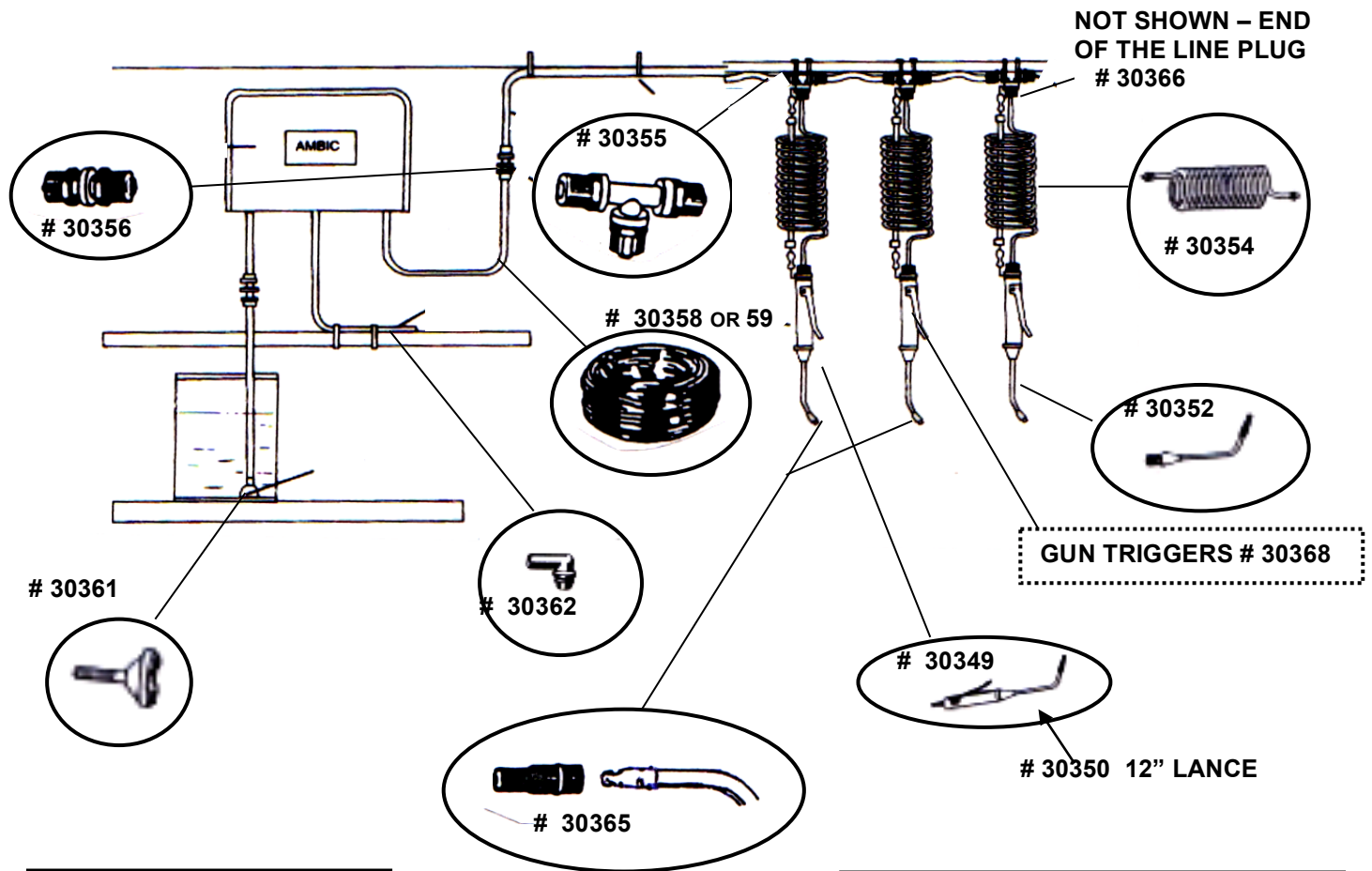

NOT SHOWN - EXTENSION KIT  
#30363 (STD) OR #30364 (EXT)



CONNECTOR NUTS #30357

- 30348 POWER UNIT ONLY
- 30376 POWER UNIT - ELECTRIC
- 30349 TEAT SPRAY GUN 6"
- 30350 TEAT SPRAY GUN 12"
- 30351 STANDARD LANCE 6"
- 30352 EXTENDED LANCE 12"
- 30353 CONTROL VALVE ASS.
- 30354 RETRACTABLE COIL
- 30355 T-CONNECTOR
- 30356 STRAIGHT CONNECTOR
- 30357 CONNECTOR NUTS
- 30358 FLEXIBLE TUBING 25'
- 30359 FLEXIBLE TUBING 100'
- 30361 LIQUID INTAKE FILTER
- 30362 VACUUM PIPE ADAPTOR
- 30363 EXTENSION KIT STD. LANCE
- 30364 EXT. KIT EXTENDED LANCE
- 30365 NOZZLE FOR GUN
- 30366 END OF LINE PLUG
- 30366 GUN TRIGGERS

# INSECT CONTROL MATERIAL

(877) 829-3505



**WE NO LONGER STOCK  
FLOWTRON BUG  
ZAPPERS , BUT WE DO  
HAVE REPLACEMENT  
BULBS! ZAPPERS ARE  
SPECIAL ORDER**

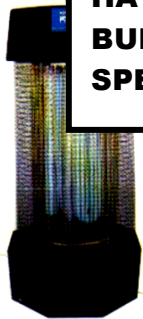

FC 8800

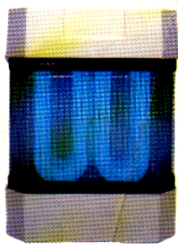

FC 7600

## FLOWTRON BULBS

# 56015	BF150SP	SHATTERPROOF
# 56010	BF100	FOR 8800
# 56010-1	BF150	
# 56011-1	BF130	
# 56013	BF130SP	SHATTERPROOF
# 56022	STARTER FOR 7500	
# 56024	STARTER FOR 8500 & 9000	
# 56032	SPACER SWITCH FOR 8500 & 9000	



## AEROXON FLY CATCHERS

- THE ORIGINAL FLY CATCHER
- INVENTED IN 1861- STILL THE BEST
- NO FUMES, NON-TOXIC
- ENVIRONMENTALLY SAFE
- CONTAINS SECRET FLY LURES

# 51094	Bulk Pack of 100
# 51091	Blister Pack of 24 cards
# 51092	Blister packed box of 12 cards
# 51092-1	#5 card of 4
# 51096	#35 box – Barn and Stable Fly Catchers
# 51096-1	#35 each

## ALSO!

### SILVA FLY PAPER TRAP

### “THE WINDOW FLY TRAP”

THE SHEET MODEL 3102  
Fly paper sheets for stables, chicken houses, milk rooms, pig houses, etc.  
# 51086 3102 pkg 6 sheets  
# 51086-1 3102 case of 24x6

WINDOW FLY TRAP 538  
The unobstrusive insect trap that helps you keep your windows free of flies and other insects.  
# 51090 4 strips  
# 51090-2 Box - 24 pkgs of 4 strips

**EASTERN CROWN, INC.  
CAN UPS THESE  
PRODUCTS SO THAT  
YOU HAVE THEM IN 3-5  
BUSINESS DAYS!**

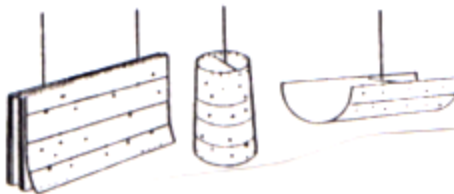

**EASTERN CROWN, INC. DISTRIBUTOR OF DAIRY SUPPLIES SINCE 1947**

# TOWELS AND DISPENSERS



## **DRY WIPE TOWELS #30275**

These natural dairy towels are extra thick to enhance absorbency for fast drying. One towel per cow eliminates waste and extra work for you or your hired man. These may even work when you forget the anniversary.

## **Wet Strength Dairy Towel #48068**

These wet strength towels are ideal for use with sanitizing solution or for any particularly demanding application. A product of this quality is essential to good dairy herd hygiene.

## Browse these other fine Towels and Accessories:

### **SINGLEFOLD TOWEL DISPENSER #30265**

White Baked Enamel. Cases of 6 individually boxed.

### **SINGLEFOLD HI-IMPACT THERMAL PLASTIC TOWEL CABINETS #30265**

9 1/4" x 12 7/16" x 6". Case of 6.

### **CABINET ROLL PAPER TOWEL HOLDER**

**#30283** White baked enamel. For 350' rolls only.

**ROLL PAPER TOWELS #30284** These towels are heavily embossed to provide the softness of home while delivering the wet strength needed for use in business and industry. 3000 sheets/roll.

### **SERVICE GRADE ROLL TOWELS #30278**

Natural 8" roll towels. 350 ft per roll.

### **TOILET TISSUE #30285**

96 rolls per case. 48,000 sheets per case.

**FACIAL TISSUE #30286** 1000 sheets per box.



### **MilkCheck Teat Wipes** Refills – INV # (48061 per) (48062 case)

MilkCheck teat wipes are impregnated with .45% Chlorhexidine Gluconate, 8.0% Isopropyl Alcohol, Glycerine and Lanolin.

- Economical
- Convenient
- Large, reusable pails
- 600 large wipes per container
- Reduced cross contamination
- Heat-sealed refill packages
- Time and labor saving because of one step udder prep
- Quick drying, with 8 % Isopropyl Alcohol to dissipate moisture